



ZULIA

10

////////// innovations:**2010**





---

**ZIVA™**

*better equipped by design*



---

## **contents:** twenty10

**06** Prologue

**08** Weight Room

**11** ZVO Evolution Series Weights

**34** ST Stability Performance Series Storage

**52** EX Expressive Series Storage Racks

**62** Studio

**65** ZVO Evolution Series Weights

**81** ST Stability Performance Series Storage

**100** To Order, Warranty, and Delivery

**104** Contact Information





## Prologue



### Refining and redefining an industry.

At Ziva, we are dedicated to the constant improvement and development of all our products. We want to change the way you look at the fitness industry. For too long there has been complacency and a lack of progress in weights, weight storage and their designs. We look beyond the boundaries of the current industry standards. Evolving and innovating new products for the growing expectations of the new sophisticated customer bases around the globe. Ziva is redefining what a fitness club can and should be to stay competitive.

Our first priority is functional design. Ziva products will work, and work well. Our designer forms are derivative of the product's function. They look exceptional because they work exceptionally. We offer refined, well thought out designs built to organize and improve the dynamics of your space.

Ziva strives to better equip your club for the future.



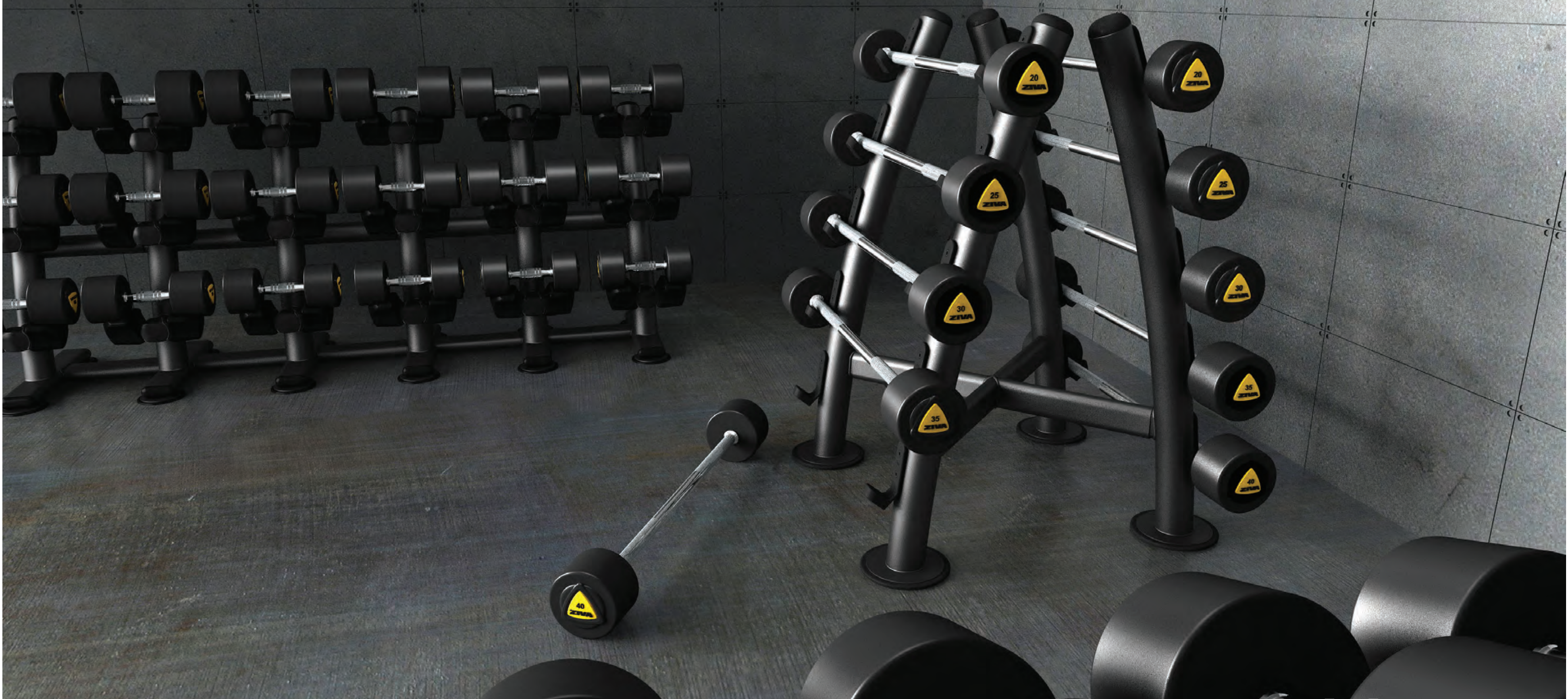

**ZIVA™ weightroom**



the **weight**: 2010

**ZIVA™** *weightroom*



**ZV□** **evolution series**

*weight discs, dumbbells, and barbells*

Innovations: **weightroom weight**



**ZVO evolution series weights:** The all new original designs from Ziva are the product of creative redesigning of our weights to *evo/ve* into more effective functioning pieces with a distinct appearance. Utilizing new materials with creativity and technical expertise to make the best available weighted products on the market today.







## ZVO evolution series urethane with color insert weight discs:

Original designs utilizing high end technology with ergonomically contoured lines. We encase these discs with a non-porous premium Urethane surface for extreme durability. ZVO evolution series grip discs feature precision casting and solid stainless steel hub inserts for a smooth action. Urethane inserts available in different color options (see specifications) for a customized look and feel.

ZVO Evolution Series urethane products have a limited 3 year warranty.

\*Patent pending.

### Order Code

ZVO-DCPU-1301  
 ZVO-DCPU-1302  
 ZVO-DCPU-1303  
 ZVO-DCPU-1304  
 ZVO-DCPU-1305  
 ZVO-DCPU-1306  
 ZVO-DCPU-1307  
 ZVO-DCPU-1308  
 ZVO-DCPU-1309  
 ZVO-DCPU-1310  
 ZVO-DCPU-1311

### Item Description

ZVO Series 1.25kg Urethane Grip Disc  
 ZVO Series 2.5kg Urethane Grip Disc  
 ZVO Series 5kg Urethane Grip Disc  
 ZVO Series 10kg Urethane Grip Disc  
 ZVO Series 15kg Urethane Grip Disc  
 ZVO Series 20kg Urethane Grip Disc  
 ZVO Series 25kg Urethane Grip Disc  
 ZVO Series Urethane Grip Disc Set 1000kg (94 pcs.)  
 ZVO Series Urethane Grip Disc Set 400kg (40 pcs.)  
 ZVO Series Urethane Grip Disc Set 300kg (36 pcs.)  
 ZVO Series Urethane Grip Disc Set 200kg (26 pcs.)

### Order Codes:

ZVO-DCPU-1301 to ZVO-DCPU-1311

### Color Options:

Yellow (YW), Red (RD), and Grey (GR).



### Weight increments:

1.25kg, 2.5 kg, 5-25kg (5kg increments)

### Features:

Solid stainless steel insert  
 Precision casting  
 Premium Urethane surface coating  
 Color urethane insert

### Warranty:

Limited 3 years.





## ZVO evolution series solid color urethane weight discs:

Original designs utilizing high end technology with ergonomically contoured lines. We encase these discs with a non-porous premium urethane surface for extreme durability. ZVO evolution series grip discs feature precision casting and solid stainless steel hub inserts for a smooth action.

ZVO Evolution Series urethane products have a limited 3 year warranty.

\*Patent pending.

### Order Code

ZVO-DCPU-1401  
 ZVO-DCPU-1402  
 ZVO-DCPU-1403  
 ZVO-DCPU-1404  
 ZVO-DCPU-1405  
 ZVO-DCPU-1406  
 ZVO-DCPU-1407  
 ZVO-DCPU-1408  
 ZVO-DCPU-1409  
 ZVO-DCPU-1410  
 ZVO-DCPU-1411

### Item Description

ZVO Series 1.25kg Urethane Grip Disc  
 ZVO Series 2.5kg Urethane Grip Disc  
 ZVO Series 5kg Urethane Grip Disc  
 ZVO Series 10kg Urethane Grip Disc  
 ZVO Series 15kg Urethane Grip Disc  
 ZVO Series 20kg Urethane Grip Disc  
 ZVO Series 25kg Urethane Grip Disc  
 ZVO Series Urethane Grip Disc Set 1000kg (94 pcs.)  
 ZVO Series Urethane Grip Disc Set 400kg (40 pcs.)  
 ZVO Series Urethane Grip Disc Set 300kg (36 pcs.)  
 ZVO Series Urethane Grip Disc Set 200kg (26 pcs.)



### Order Codes:

ZVO-DCPU-1401 to ZVO-DCPU-1411

### Color Options:

Black (BK), Red (RD).



### Warranty:

Limited 3 years.

### Weight increments:

1.25kg, 2.5 kg, 5-25kg (5kg increments)

### Features:

Solid stainless steel insert  
 Precision casting  
 Premium urethane surface coating



**ZVO evolution series urethane dumbbells:**

Original designs utilizing high end technology with ergonomically contoured lines. We encase these dumbbells with a non-porous premium urethane surface for extreme durability. ZVO evolution series feature precision casting and triple chromed comfortable ergonomic grips that stay in the hands with less effort. Urethane endcaps available in different color options (see specifications) for a customized look and feel.

ZVO Evolution Series urethane products have a limited 3 year warranty.

\*Patent pending.

| Order Code    | Item Description                                    |
|---------------|---|
| ZVO-DBPU-1001 | ZVO Series 2-20Kg Urethane Dumbbell Set (10 pairs)  |
| ZVO-DBPU-1002 | ZVO Series 12-30Kg Urethane Dumbbell Set (10 pairs) |
| ZVO-DBPU-1003 | ZVO Series 22-30Kg Urethane Dumbbell Set (5 pairs)  |
| ZVO-DBPU-1004 | ZVO Series 32-40Kg Urethane Dumbbell Set (5 pairs)  |
| ZVO-DBPU-1005 | ZVO Series 42-50Kg Urethane Dumbbell Set (5 pairs)  |

|   |  |  |   |  |
|---|--|--|---|--|
| <p><b>Order Codes:</b><br/>ZVO-DBPU-1001 to ZVO-DBPU-1005</p>   | <p><b>Color Options:</b><br/>Yellow (YW), Red (RD), and Grey (GR).</p> | <p><b>Warranty:</b><br/>Limited 3 years.</p> |   |  |
| <p><b>Grip diameter options:</b><br/>32mm</p> <p><b>Weight increments:</b><br/>2-50kg (2kg increments)</p>  |  |  |   |  |
| <p><b>Features:</b></p> <table border="0"> <tr> <td>Precision casting<br/>Premium Urethane surface</td> <td>Color urethane endcaps<br/>Triple chromed ergonomic grips</td> </tr> </table> |  |  | Precision casting<br>Premium Urethane surface | Color urethane endcaps<br>Triple chromed ergonomic grips |
| Precision casting<br>Premium Urethane surface   | Color urethane endcaps<br>Triple chromed ergonomic grips               |  |   |  |





**ZVO evolution series urethane barbells:**

Original designs utilizing high end technology with ergonomically contoured lines. We encase these barbells with a non-porous premium urethane surface for extreme durability. ZVO evolution series feature precision casting and triple chromed precision knurled grips that stay in the hands with less effort. Urethane endcaps available in different color options (see specifications) for a customized look and feel.

ZVO Evolution Series urethane products have a limited 3 year warranty.

\*Patent pending.

| Order Code    | Item Description  |
|---------------|---|
| ZVO-BSPU-1101 | ZVO Series 10-20Kg Urethane Barbell Set (2.5kg Increments, 5pcs.) |
| ZVO-BSPU-1102 | ZVO Series 25-45Kg Urethane Barbell Set (5kg Increments, 5pcs.)   |
| ZVO-BSPU-1103 | ZVO Series 10-45Kg Urethane Barbell Set (10pcs.)                  |



|   |  |  |  |                                  |                   |                        |
|---|--|--|--|----------------------------------|-------------------|------------------------|
| <p><b>Order Codes:</b><br/>ZVO-BSPU-1101 to ZVO-BSPU-1103</p>   | <p><b>Color Options:</b><br/>Yellow (YW), Red (RD), and Grey (GR).</p>    | <p><b>Warranty:</b><br/>Limited 3 years.</p> |  |                                  |                   |                        |
| <p><b>Grip diameter options:</b><br/>32mm</p> <p><b>Weight increments:</b><br/>10-45kg (2.5kg increments 10-20kg, 5kg increments 25-45kg)</p> | <p><b>Features:</b></p> <table border="0"> <tr> <td>Triple chromed precision knurled grips</td> <td>Premium urethane surface coating</td> </tr> <tr> <td>Precision casting</td> <td>Color urethane endcaps</td> </tr> </table> |  | Triple chromed precision knurled grips | Premium urethane surface coating | Precision casting | Color urethane endcaps |
| Triple chromed precision knurled grips  | Premium urethane surface coating   |  |  |                                  |                   |                        |
| Precision casting   | Color urethane endcaps   |  |  |                                  |                   |                        |





## ZVO evolution series urethane EZ curl barbells:

Original designs utilizing high end technology with ergonomically contoured lines. ZVO series EZ Curl grips help to keep the user's grip in a more comfortable and neutral position during a variety of barbell exercises. We encase these barbells with a non-porous premium urethane surface for extreme durability. ZVO evolution series feature precision casting and triple chromed comfortable ergonomic grips that stay in the hands with less effort. Urethane endcaps available in different color options (see specifications) for a customized look and feel.

ZVO Evolution Series urethane products have a limited 3 year warranty.

\*Patent pending.

| Order Code    | Item Description  |
|---------------|---|
| ZVO-BCPU-1201 | ZVO Series 10-20Kg Urethane EZ Curl Barbell Set (2.5kg Increments, 5pcs.) |
| ZVO-BCPU-1202 | ZVO Series 25-45Kg Urethane EZ Curl Barbell Set (5kg Increments, 5pcs.)   |
| ZVO-BCPU-1203 | ZVO Series 10-45Kg Urethane EZ Curl Barbell Set (10pcs.)                  |

### Order Codes:

ZVO-BCPU-1201 to ZVO-BCPU-1203

### Grip diameter options:

32mm

### Weight increments:

10-45kg (2.5kg increments 10-20kg, 5kg increments 25-45kg)

### Color Options:

Yellow (YW), Red (RD), and Grey (GR).



### Warranty:

Limited 3 years.

### Features:

Triple chromed ergonomic EZ curl grips  
Precision casting

Color urethane endcaps  
Premium urethane surface coating





## ZVO evolution series rubber weight discs:

Original designs utilizing high end technology with ergonomically contoured lines. We encase these discs with a durable virgin rubber surface. ZVO evolution series grip discs feature precision casting and solid stainless steel hub inserts for a smooth action. Elastomer weight designators are available in different color options (see specifications) for a customized look and feel.

ZVO Evolution Series rubber products have a limited 1 year warranty.

\*Patent pending.

### Order Code

ZVO-DCRB-2301  
 ZVO-DCRB-2302  
 ZVO-DCRB-2303  
 ZVO-DCRB-2304  
 ZVO-DCRB-2305  
 ZVO-DCRB-2306  
 ZVO-DCRB-2307  
 ZVO-DCRB-2308  
 ZVO-DCRB-2309  
 ZVO-DCRB-2310  
 ZVO-DCRB-2311

### Item Description

ZVO Series 1.25kg Rubber Grip Disc  
 ZVO Series 2.5kg Rubber Grip Disc  
 ZVO Series 5kg Rubber Grip Disc  
 ZVO Series 10kg Rubber Grip Disc  
 ZVO Series 15kg Rubber Grip Disc  
 ZVO Series 20kg Rubber Grip Disc  
 ZVO Series 25kg Rubber Grip Disc  
 ZVO Series Rubber Grip Disc Set 1000kg (94 pcs.)  
 ZVO Series Rubber Grip Disc Set 400kg (40 pcs.)  
 ZVO Series Rubber Grip Disc Set 300kg (36 pcs.)  
 ZVO Series Rubber Grip Disc Set 200kg (26 pcs.)



### Order Codes:

ZVO-DCRB-2301 to ZVO-DCRB-2311

### Color Options:

Yellow (YW), Red (RD), and Grey (GR).



### Weight increments:

1.25kg, 2.5 kg, 5-25kg (5kg increments)

### Features:

Solid stainless steel insert  
 Precision casting  
 Color elastomer indicators

Durable virgin rubber  
 surface coating

### Warranty:

Limited 1 year.





**ZVO evolution series rubber dumbbells:**

Original designs utilizing high end technology with ergonomically contoured lines. We encase these dumbbells with a durable virgin rubber surface. ZVO evolution series feature precision casting and triple chromed comfortable ergonomic grips that stay in the hands with less effort. Urethane endcaps available in different color options (see specifications) for a customized look and feel.

ZVO Evolution Series rubber products have a limited 1 year warranty.

\*Patent pending.

| Order Code    | Item Description                                  |
|---------------|---|
| ZVO-DBRB-2001 | ZVO Series 2-20Kg Rubber Dumbbell Set (10 pairs)  |
| ZVO-DBRB-2002 | ZVO Series 12-30Kg Rubber Dumbbell Set (10 pairs) |
| ZVO-DBRB-2003 | ZVO Series 22-30Kg Rubber Dumbbell Set (5 pairs)  |
| ZVO-DBRB-2004 | ZVO Series 32-40Kg Rubber Dumbbell Set (5 pairs)  |
| ZVO-DBRB-2005 | ZVO Series 42-50Kg Rubber Dumbbell Set (5 pairs)  |

|  |  |   |
|--|--|---|
| <p><b>Order Codes:</b><br/>ZVO-DBRB-2001 to ZVO-DBRB-2005</p>  | <p><b>Color Options:</b><br/>Yellow (YW), Red (RD), and Grey (GR).</p>  | <p><b>Warranty:</b><br/>Limited 1 year.</p> |
| <p><b>Grip diameter options:</b><br/>32mm</p> <p><b>Weight increments:</b><br/>2-50kg (2kg increments)</p> | <p><b>Features:</b><br/>Triple chromed ergonomic grips    Durable virgin rubber surface coating<br/>Precision casting<br/>Color urethane endcaps</p>         |   |





**ZVO evolution series rubber barbells:**

Original designs utilizing high end technology with ergonomically contoured lines. We encase these barbells with a durable virgin rubber surface. ZVO evolution series feature precision casting and triple chromed precision knurled grips that stay in the hands with less effort. Urethane endcaps available in different color options (see specifications) for a customized look and feel.

ZVO Evolution Series rubber products have a limited 1 year warranty.

\*Patent pending.

| Order Code    | Item Description  |
|---------------|---|
| ZVO-BSRB-2101 | ZVO Series 10-20Kg Rubber Barbell Set (2.5kg Increments, 5pcs.) |
| ZVO-BSRB-2102 | ZVO Series 25-45Kg Rubber Barbell Set (5kg Increments, 5pcs.)   |
| ZVO-BSRB-2103 | ZVO Series 10-45Kg Rubber Barbell Set (10pcs.)                  |

|   |  |   |  |                        |                   |                                       |
|---|--|---|--|------------------------|-------------------|---------------------------------------|
| <p><b>Order Codes:</b><br/>ZVO-BSRB-2101 to ZVO-BSRB-2103</p>   | <p><b>Color Options:</b><br/>Yellow (YW), Red (RD), and Grey (GR).</p> | <p><b>Warranty:</b><br/>Limited 1 year.</p> |  |                        |                   |                                       |
| <p><b>Grip diameter options:</b><br/>32mm</p> <p><b>Weight increments:</b><br/>10-45kg (2.5kg increments 10-20kg, 5kg increments 25-45kg)</p>   |  |   |  |                        |                   |                                       |
| <p><b>Features:</b></p> <table border="0"> <tr> <td>Triple chromed precision knurled grips</td> <td>Color urethane endcaps</td> </tr> <tr> <td>Precision casting</td> <td>Durable virgin rubber surface coating</td> </tr> </table> |  |   | Triple chromed precision knurled grips | Color urethane endcaps | Precision casting | Durable virgin rubber surface coating |
| Triple chromed precision knurled grips  | Color urethane endcaps   |   |  |                        |                   |                                       |
| Precision casting   | Durable virgin rubber surface coating                                  |   |  |                        |                   |                                       |





## ZVO evolution series rubber easy grip barbells:

Original designs utilizing high end technology with ergonomically contoured lines. ZVO series EZ Curl grips help to keep the user's grip in a more comfortable and neutral position during a variety of barbell exercises. We encase these barbells with a durable virgin rubber surface. ZVO evolution series feature precision casting and triple chromed comfortable ergonomic grips that stay in the hands with less effort. Urethane endcaps available in different color options (see specifications) for a customized look and feel.

ZVO Evolution Series rubber products have a limited 1 year warranty.

\*Patent pending.

| Order Code    | Item Description  |
|---------------|---|
| ZVO-BCRB-2201 | ZVO Series 10-20Kg Rubber EZ Grip Barbell Set (2.5kg Increments, 5pcs.) |
| ZVO-BCRB-2202 | ZVO Series 25-45Kg Rubber EZ Grip Barbell Set (5kg Increments, 5pcs.)   |
| ZVO-BCRB-2203 | ZVO Series 10-45Kg Rubber EZ Grip Barbell Set (10pcs.)                  |

|   |   |   |
|---|---|---|
| <b>Order Codes:</b><br>ZVO-BCRB-2201 to ZVO-BCRB-2203                   | <b>Color Options:</b><br>Yellow (YW), Red (RD), and Grey (GR).                          | <b>Warranty:</b><br>Limited 1 year.                             |
| <b>Grip diameter options:</b><br>32mm                                   | <b>Weight increments:</b><br>10-45kg (2.5kg increments 10-20kg, 5kg increments 25-45kg) |   |
| <b>Features:</b><br>Triple chromed ergonomic grips<br>Precision casting |   | Durable virgin rubber surface coating<br>Color urethane endcaps |





thestorage: 2010

**ZIVA™** *weightroom*





**ST stability performance series**

*dumbbell and barbell storage racks and disc storage trees*

Innovations: **weight storage**



**ST performance series weight storage:** The next generation of weight storage. Striking streamlined designs can transform the most modest spaces into exciting areas for weight lifting. Effective designs efficiently utilize floor space. We use our heavy gauged ST (Stability) round tube steel for a strong and stable structure under heavy loads. The ST Performance Series is the ultimate combination of designer forms and solid construction.







### ST performance series 10 pair horizontal dumbbell rack:

The next generation of weight room storage. For your larger spaces, the ST performance 10 pair horizontal dumbbell rack holds 20 large or small dumbbells. Features heavy gauged ST (Stability) round tube steel for a strong and stable structure, and baked powdered coating. Forward tilted designer saddles create a superior angle for ease of removal and replacement of dumbbells. Saddles are made from impact resistant nylon to protect and prevent marking of dumbbells. ST Performance Series is the ultimate combination of designer forms and solid construction.

ST Performance Series storage products have a limited 10 year warranty.

\*Patent pending.

| Order Code    | Item Description                                       |
|---------------|--|
| ZST-HF10-5104 | ST Performance Series 10 pair Horizontal Frame DB Rack |

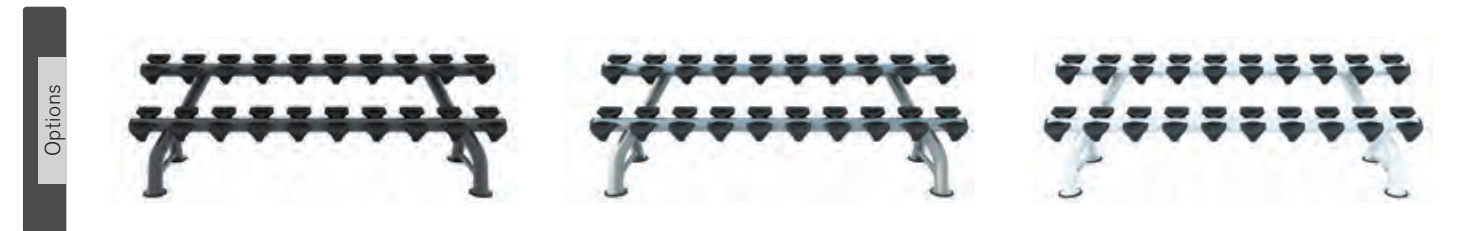

|  |   |                                       |
|--|---|---------------------------------------|
| <b>Order Codes:</b><br>ZST-HF10-5104                                       |  <b>Frame Color Options:</b><br>Graphite (GF), Silver (SV) and White (WT). | <b>Warranty:</b><br>Limited 10 years. |
| <b>Dimensions:</b><br>Width: 236.0 cm<br>Height: 80.0 cm<br>Depth: 76.0 cm | <b>Features:</b><br>Horizontal style frame      Baked powdered coating<br>ST round tube steel      Stores 10 pairs<br>Impact resistant saddles                  |                                       |
| <b>Weight</b><br>Weight: 70kg  |   |                                       |





### ST performance series 5 pair horizontal dumbbell rack:

The next generation of weight room storage. ST performance 5 pair horizontal dumbbell rack was designed to hold heavy weights while fitting into smaller spaces. Features heavy gauged ST (Stability) round tube steel for a strong and stable structure, and baked powdered coating. Forward tilted designer saddles create a superior angle for ease of removal and replacement of dumbbells. Saddles are made from impact resistant nylon to protect and prevent marking of dumbbells. ST Performance Series is the ultimate combination of designer forms and solid construction.

ST Performance Series storage products have a limited 10 year warranty.

\*Patent pending.

| Order Code    | Item Description                                      |
|---------------|---|
| ZST-HF05-5103 | ST Performance Series 5 pair Horizontal Frame DB Rack |



**Order Codes:**  
ZST-HF05-5103

**Dimensions:**  
Width: 116.0 cm  
Height: 80.0 cm  
Depth: 76.0 cm

**Weight**  
Weight: 40kg



**Frame Color Options:**  
Graphite (GF), Silver (SV) and White (WT).

**Features:**  
Horizontal style frame  
ST round tube steel  
Impact resistant saddles  
Baked powdered coating  
Stores 5 pairs

**Warranty:**  
Limited 10 years.





### ST performance series 3 tier vertical dumbbell rack:

The next generation of weight storage. Designed to minimize the depth of the rack, saving you space off the wall. Features heavy gauged ST (Stability) round tube steel for a strong and stable structure, and baked powdered coating. Designer saddles are bolted down to make a secure seat for dumbbells and are made from impact resistant nylon to protect and prevent marking of dumbbells. ST Performance Series is the ultimate combination of designer forms and solid construction.

ST Performance Series storage products have a limited 10 year warranty.

\*Patent pending.

| Order Code    | Item Description   |
|---------------|--|
| ZST-LF18-5001 | ST Performance Series 3 Tier Vertical DB Rack (holds 18 pcs) |

**Order Codes:**  
ZST-LF18-5001

**Dimensions:**  
Width: 229.0 cm  
Height: 88.0 cm  
Depth: 59.0 cm

**Weight**  
Weight: 55kg



**Frame Color Options:**  
Graphite (GF), Silver (SV) and White (WT).

**Features:**  
ST round tube steel  
Impact resistant saddles  
Baked powdered coating  
Stores 9 pairs

**Warranty:**  
Limited 10 years.





### ST performance series X-brace dumbbell rack:

The next generation of weight storage. ST Performance X-brace dumbbell racks are made for hard use. The compact design increases space efficiency. Features heavy gauged ST (Stability) round tube steel for a strong and stable structure, and baked powdered coating. Designer saddles are bolted down to make a secure seat for dumbbells and are made from impact resistant nylon to protect and prevent marking of dumbbells. Optional weight indicators available. ST Performance Series is the ultimate combination of designer forms and solid construction.

ST Performance Series storage products have a limited 10 year warranty.

\*Patent pending.

| Order Code    | Item Description  |
|---------------|---|
| ZST-VX10-5107 | ST Performance Series Vertical X-Brace Dumbbell Rack (10 pairs) |



**Order Codes:**  
ZST-AF10-5107

**Dimensions:**  
Width: 90.0 cm  
Height: 123.0 cm  
Depth: 80.0 cm

**Weight**  
Weight: 60kg



**Frame Color Options:**  
Graphite (GF), Silver (SV) and White (WT).

**Features:**  
X-brace design  
ST round tube steel  
Impact resistant saddles  
Baked powdered coating  
Stores 10 pairs

**Warranty:**  
Limited 10 years.





### ST performance series X-brace barbell rack:

The next generation of weight storage. ST Performance X-brace barbell racks are made for hard use. The compact design increases space efficiency. Features heavy gauged ST (Stability) round tube steel for a strong and stable structure, and baked powdered coating. ST Performance Series is the ultimate combination of designer forms and solid construction.

ST Performance Series storage products have a limited 10 year warranty.

\*Patent pending.

| Order Code    | Item Description  |
|---------------|---|
| ZST-VX10-5108 | ST Performance Series Vertical X-Brace Barbell Rack (10 pcs.) |

**Order Codes:**  
ZST-AF10-5108

**Dimensions:**  
Width: 80.0 cm  
Height: 124.0 cm  
Depth: 91.0 cm

**Weight**  
Weight: 55kg



**Frame Color Options:**  
Graphite (GF), Silver (SV) and White (WT).

**Features:**  
X-brace design  
ST round tube steel  
Baked powdered coating  
Stores 10 pcs.

**Warranty:**  
Limited 10 years.





### ST performance series 5 piece vertical barbell rack:

The next generation of weight storage. ST Performance 5 piece vertical barbell racks are made for hard use. Compact design increases space efficiency saving space off the wall. Features heavy gauged ST (Stability) round tube steel for a strong and stable structure, and baked powdered coating. ST Performance Series is the ultimate combination of designer forms and solid construction.

ST Performance Series storage products have a limited 10 year warranty.

\*Patent pending.

| Order Code    | Item Description                                    |
|---------------|---|
| ZST-VL05-5109 | ST Performance Series 5 piece Vertical Barbell Rack |

**Order Codes:**  
ZST-VL05-5109

**Dimensions:**  
Width: 80.0 cm  
Height: 124.0 cm  
Depth: 69.0 cm

**Weight**  
Weight: 45kg



**Frame Color Options:**  
Graphite (GF), Silver (SV) and White (WT).

**Features:**  
Space saving design  
ST round tube steel  
Baked powdered coating  
Stores 5 pcs.

**Warranty:**  
Limited 10 years.





The ZST-DCTR-5202 has optional storage for bars.

### ST performance series disc storage station:

The next generation of weight storage. The ST Performance disc storage station is designed to organize your weightroom. Heavy gauged ST (Stability) round tube steel for a strong and stable structure enables users to store grip discs off the floor, creating clean, clutter free spaces. Polished stainless steel disc spindles and rounded insert end caps reduce friction and make it easy to remove and replace discs. ST Performance Series is the ultimate combination of designer forms and solid construction.

ST Performance Series storage products have a limited 10 year warranty.

\*Patent pending.

| Order Code    | Item Description   |
|---------------|--|
| ZST-DCTR-5201 | ST Performance Series Disc Storage Station               |
| ZST-DCTR-5202 | ST Performance Series Disc Storage Station w/bar holders |

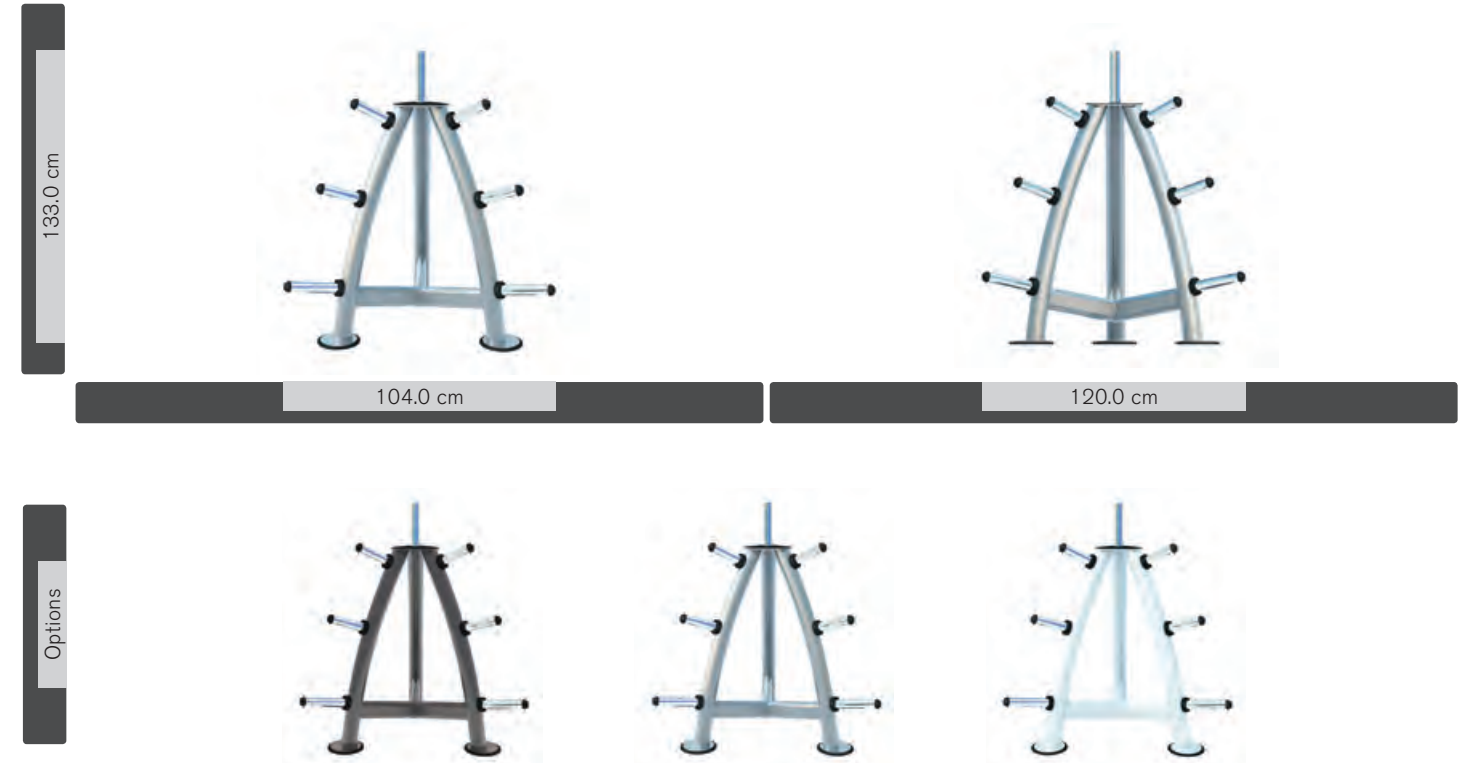

**Order Codes:**  
ZST-DCTR-5201

**Dimensions:**  
Width: 120.0 cm  
Height: 133.0 cm  
Depth: 104.0 cm

**Weight**  
Weight: 40kg



**Frame Color Options:**  
Graphite (GF), Silver (SV) and White (WT).

**Features:**  
3 sided design  
ST round tube steel  
Baked powdered coating  
Optional bar storage  
10 polished stainless steel storage spindles

**Warranty:**  
Limited 10 years.



# EX expressive series

*dumbbell storage racks*

Innovations: **designer weight storage**





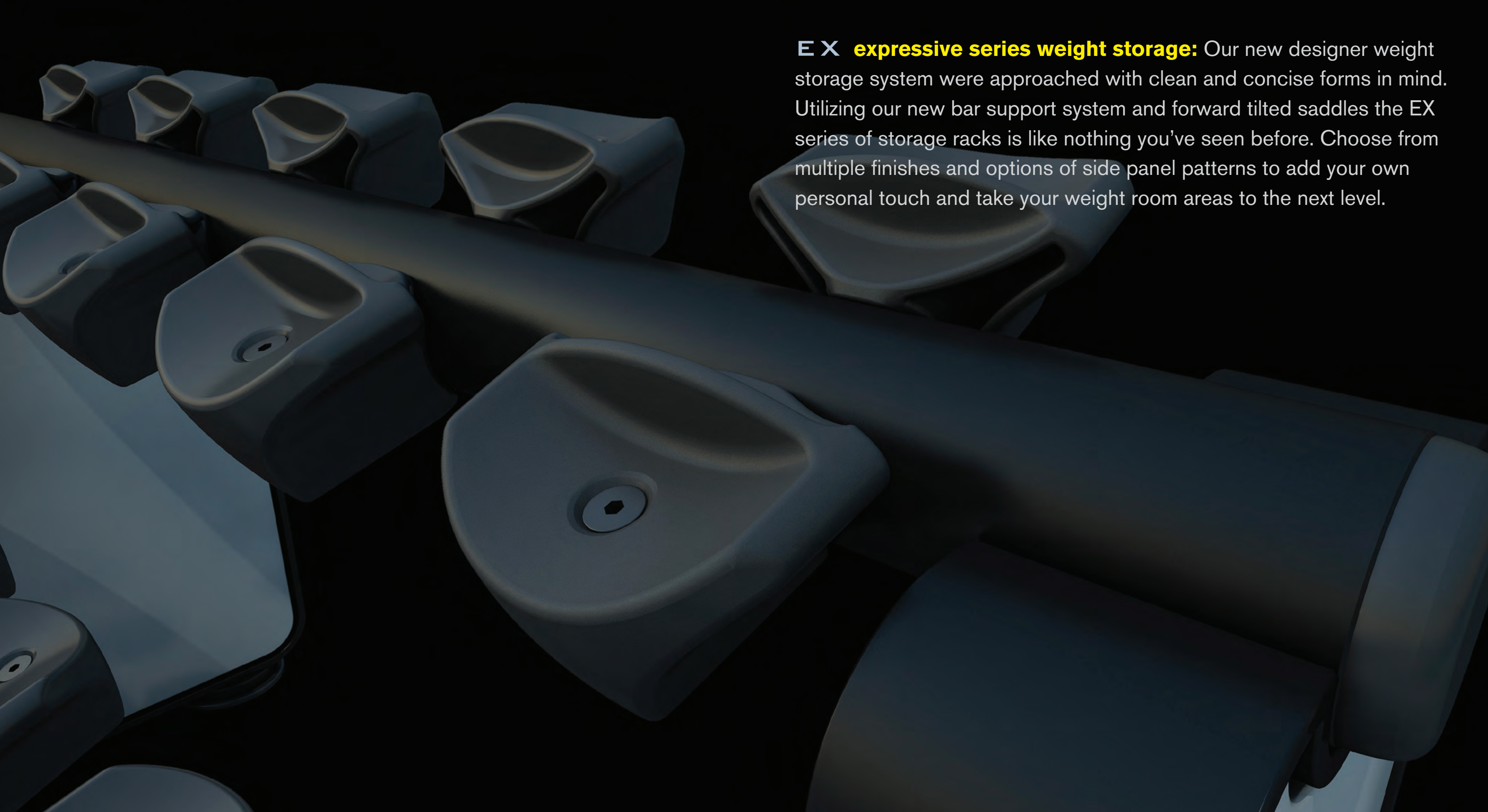

**EX expressive series weight storage:** Our new designer weight storage system were approached with clean and concise forms in mind. Utilizing our new bar support system and forward tilted saddles the EX series of storage racks is like nothing you've seen before. Choose from multiple finishes and options of side panel patterns to add your own personal touch and take your weight room areas to the next level.



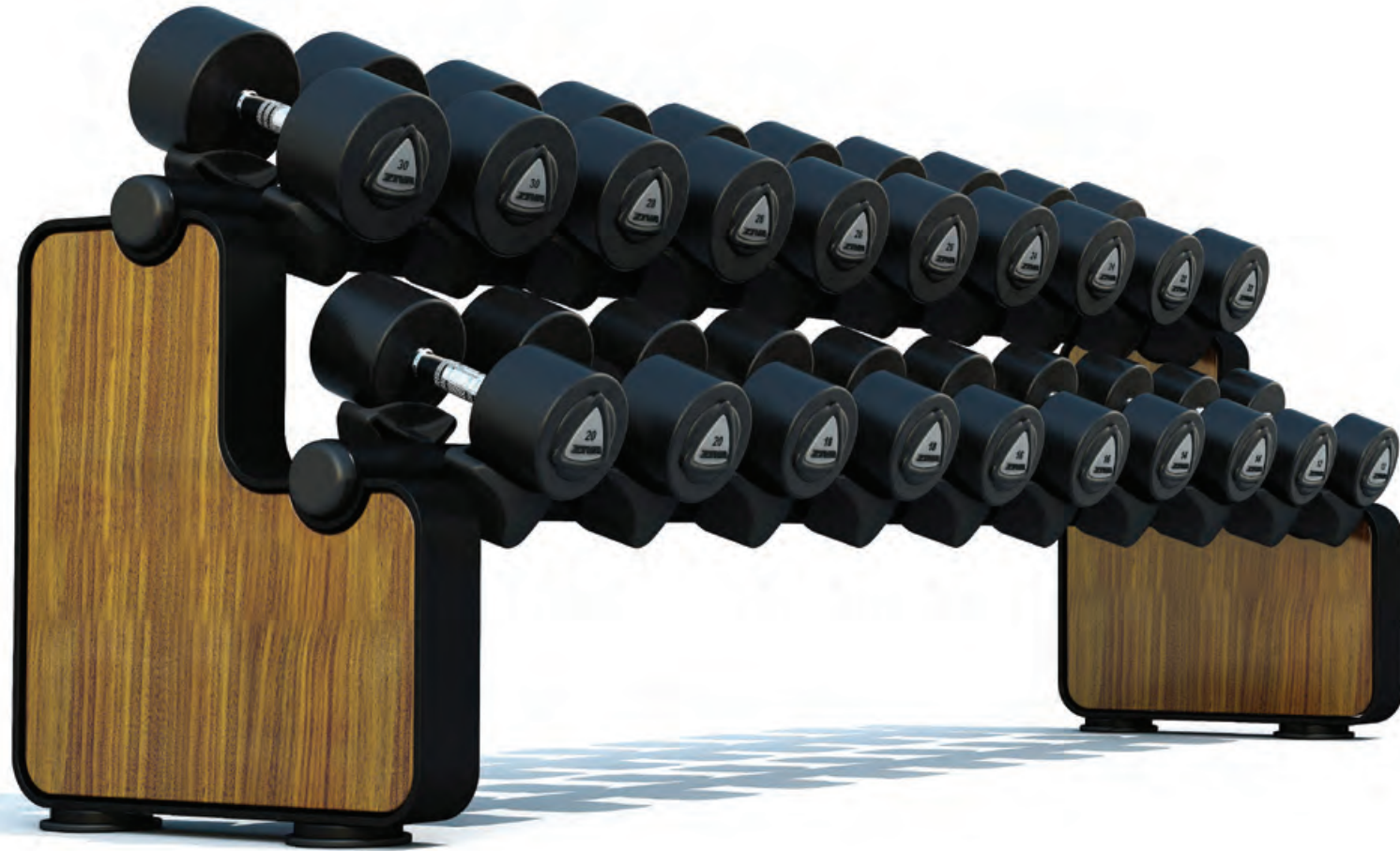

**EX expressive series horizontal 10 pair dumbbell racks:**

Our new designer weight storage system were approached with clean and concise forms in mind. The EX series of storage racks is like nothing you've seen before utilizing our new bar support system and forward tilted saddles. Choose from multiple finishes and options† of side panel patterns to add your own personal touch and take your weight room areas to the next level.

†Please inquire about custom frame finishes and panels not listed.

EX Expressive Series storage products have a limited 10 year warranty.

\*Patent pending.

| Order Code    | Item Description                                      |
|---------------|---|
| ZEX-DB10-7002 | EX Expressive Series Horizontal 10 pair Dumbbell Rack |

**Order Codes:**  
ZEX-DB10-7002

**Dimensions:**  
Width: 258.0 cm  
Height: 81.0 cm  
Depth: 64.0 cm

**Weight**  
Weight: 80kg



**Frame Color Options:**  
Black (BK), Grey (GR), White (WT), Brushed Stainless (BS)

**Features:**  
Horizontal style frame  
Forward tilted saddles  
Baked powdered coating  
Stores 10 pairs

**Warranty:**  
Limited 10 years.



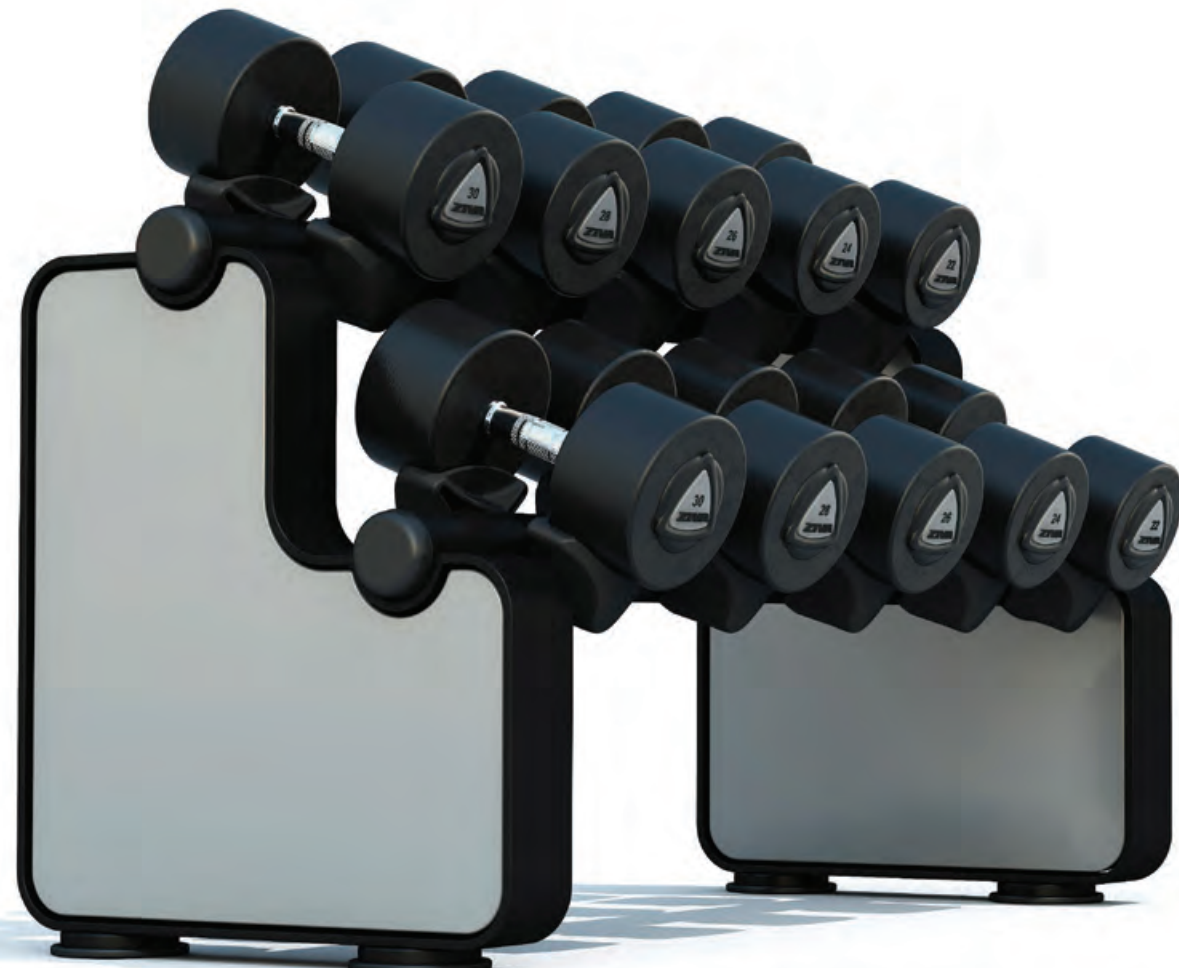

### EX expressive series horizontal 5 pair dumbbell racks:

Our new designer weight storage system were approached with clean and concise forms in mind. The EX series of storage racks is like nothing you've seen before utilizing our new bar support system and forward tilted saddles. Choose from multiple finishes and options† of side panel patterns to add your own personal touch and take your weightroom areas to the next level.

†Please inquire about custom frame finishes and panels not listed.

EX Expressive Series storage products have a limited 10 year warranty.

\*Patent pending.

| Order Code    | Item Description                                     |
|---------------|--|
| ZEX-DB05-7001 | EX Expressive Series Horizontal 5 pair Dumbbell Rack |



**Order Codes:**  
ZEX-DB05-7001

**Dimensions:**  
Width: 138.0 cm  
Height: 81.0 cm  
Depth: 64.0 cm

**Weight**  
Weight: 50kg



**Frame Color Options:**  
Black (BK), Grey (GR), White (WT), Brushed Stainless (BS)

**Features:**  
Horizontal style frame  
Forward tilted saddles  
Baked powdered coating  
Stores 5 pairs

**Warranty:**  
Limited 10 years.



# ////////// designerstorage





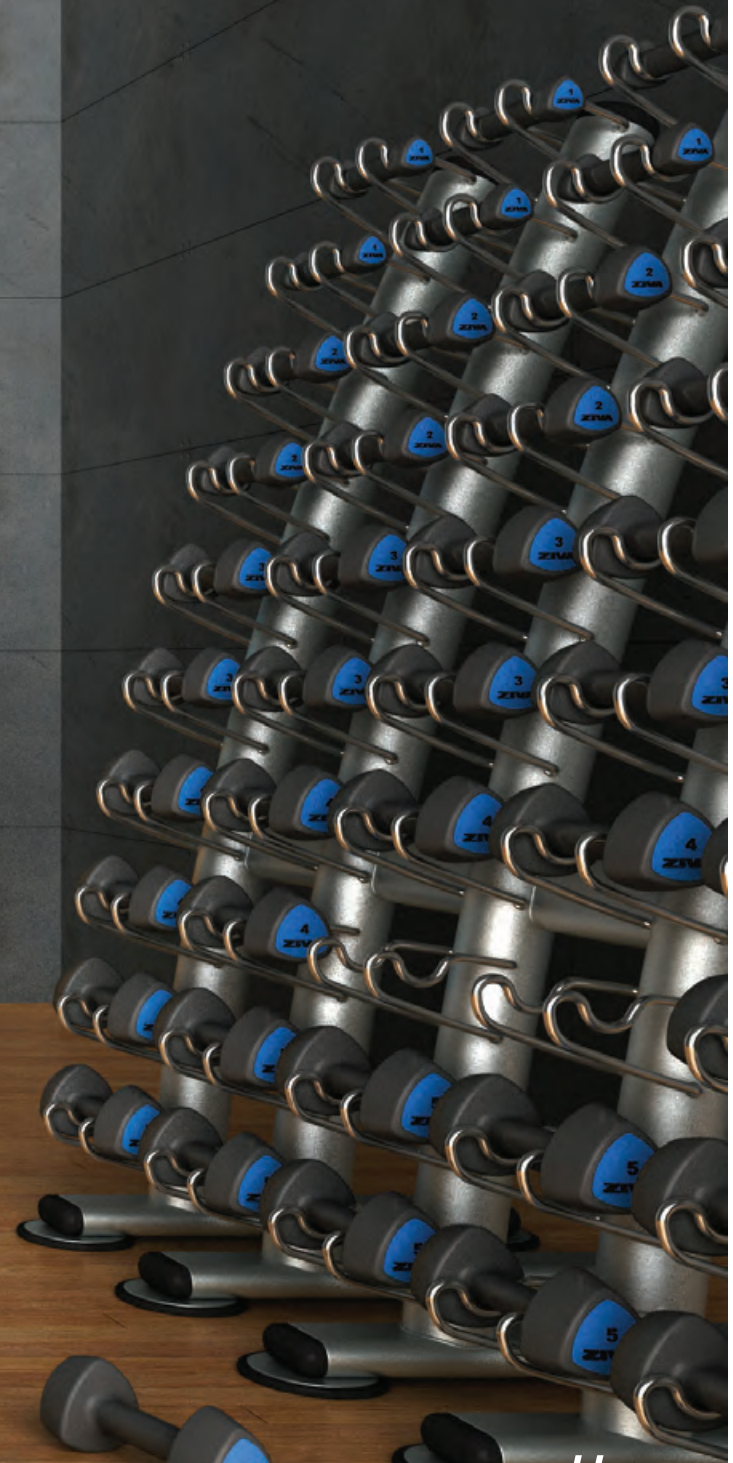
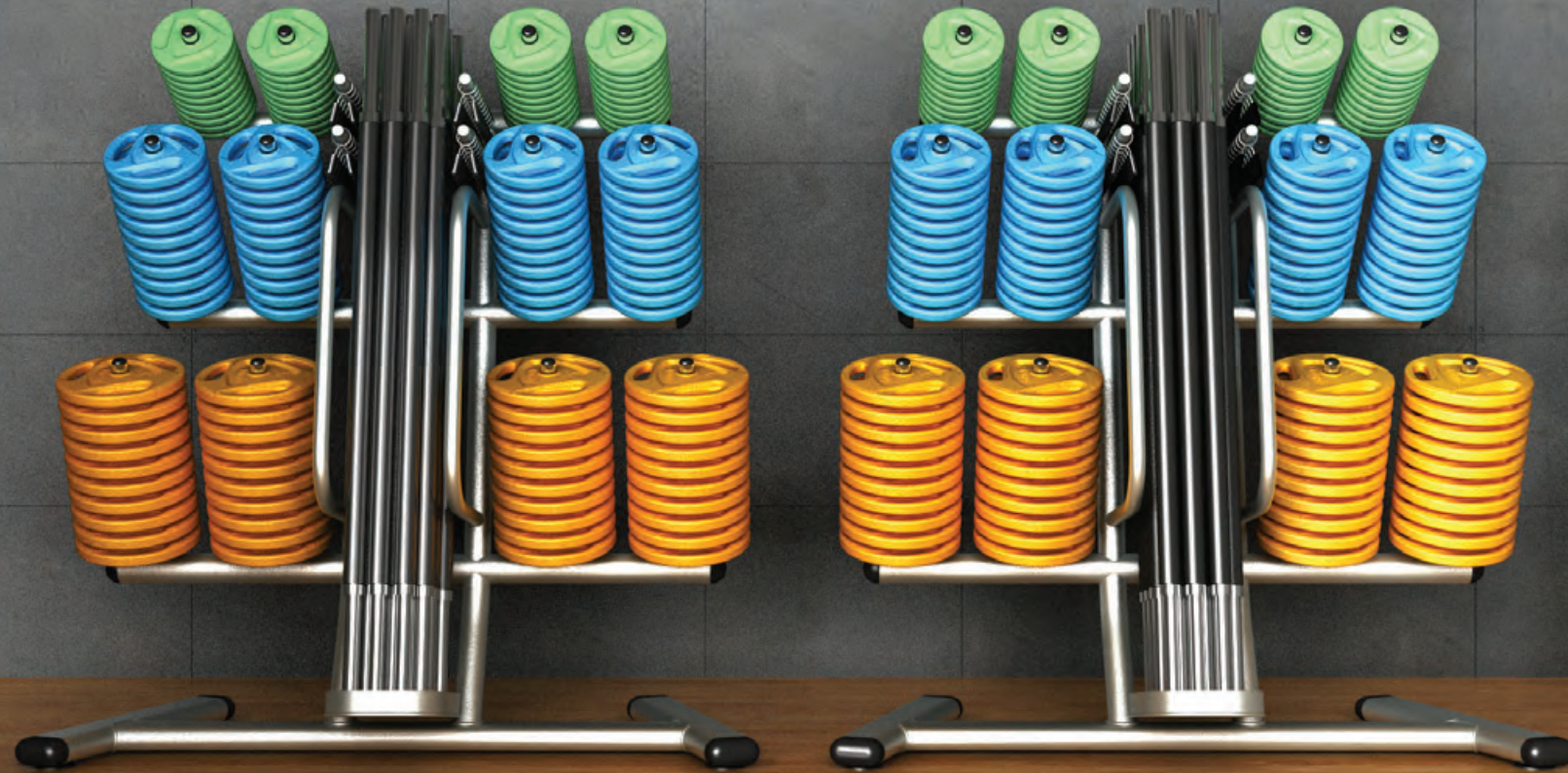

**ZIVA™** *studio*



the weight: 2010

ZIVA™ studio



ZVO evolution series

Studio dumbbells, discs, kettlebells, and medicine balls

Innovations: **studio weight**



**ZVQ evolution series studio weights:** The all new original designs from Ziva are the product of creatively redesigning our studio weights to *evolve* into more effective functioning pieces with a distinct appearance. Utilizing new materials with creativity and technical expertise to make the best available weighted products on the market today.

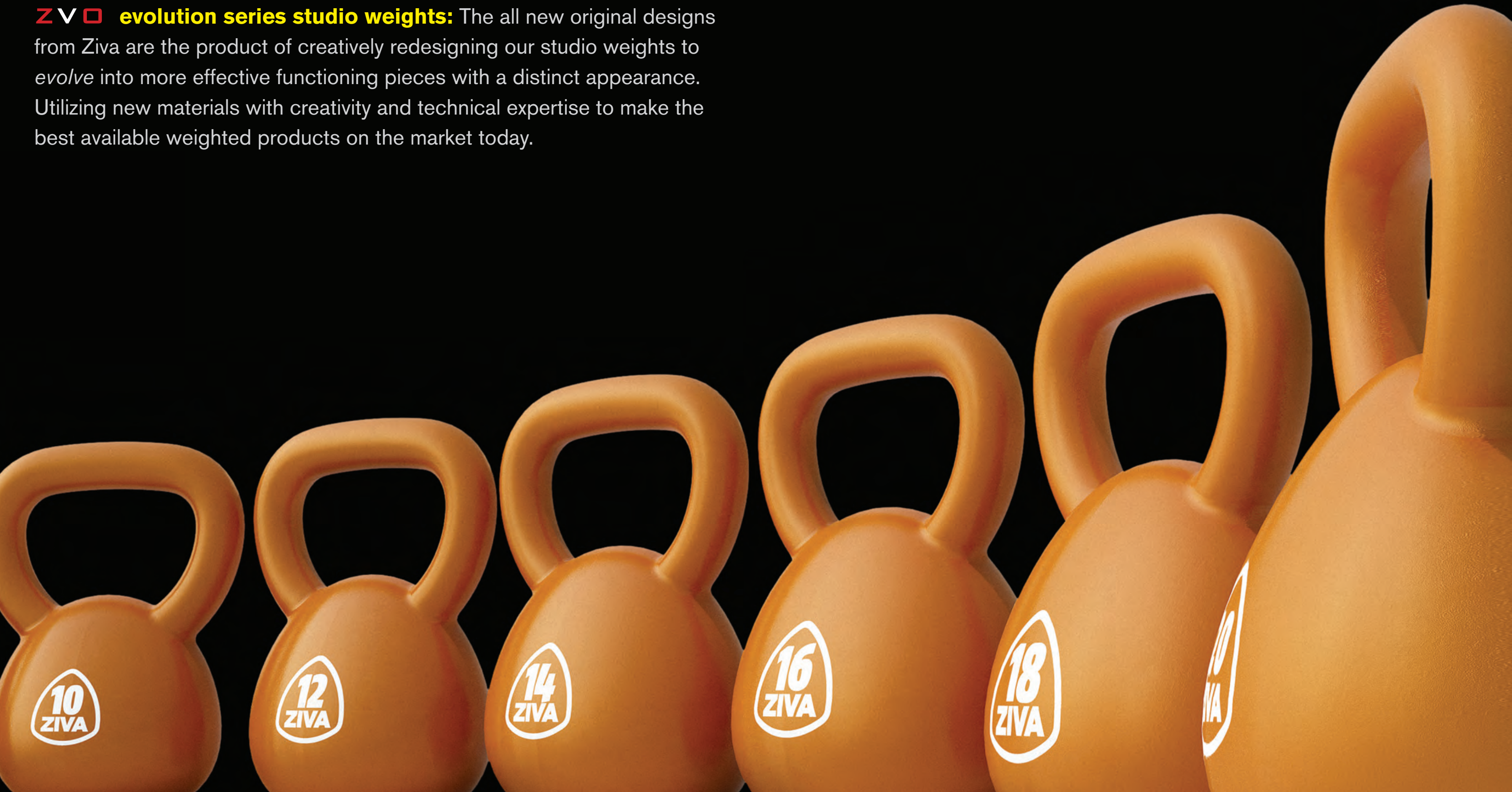





## ZVO evolution series urethane and rubber studio tribells:

The new ZVO series studio dumbbells are uniquely shaped to stand out in any area. The flat sided tribell design prevent dumbbells from rolling away during classes and drop set exercises making them the standard for a clean organized space. They're encased in a choice of non-porous premium urethane surface for extreme durability or durable virgin rubber. Featuring large weight number indicators for easy legibility, colored elastomer inserts and slip resistant texturized handles. ZVO Evolution studio dumbbells are a great addition to any studio or weight room spaces.

ZVO Evolution Series studio urethane products have a limited 3 year warranty, studio rubber products have a limited 1 year warranty.

\*Patent pending.

### Order Code

ZVO-PU05-1701  
 ZVO-PU10-1702  
 ZVO-PU20-1703  
 ZVO-PU30-1704  
 ZVO-PU40-1705  
 ZVO-PU50-1706  
 ZVO-PU60-1707  
 ZVO-RB05-2701  
 ZVO-RB10-2702  
 ZVO-RB20-2703  
 ZVO-RB30-2704  
 ZVO-RB40-2705  
 ZVO-RB50-2706  
 ZVO-RB60-2707

### Item Description

ZVO series 0.5kg Urethane Hand Weight  
 ZVO series 1kg Urethane Hand Weight  
 ZVO series 2kg Urethane Hand Weight  
 ZVO series 3kg Urethane Hand Weight  
 ZVO series 4kg Urethane Hand Weight  
 ZVO series 5kg Urethane Hand Weight  
 ZVO series 6kg Urethane Hand Weight  
 ZVO series 0.5kg Rubber Hand Weight  
 ZVO series 1kg Rubber Hand Weight  
 ZVO series 2kg Rubber Hand Weight  
 ZVO series 3kg Rubber Hand Weight  
 ZVO series 4kg Rubber Hand Weight  
 ZVO series 5kg Rubber Hand Weight  
 ZVO series 6kg Rubber Hand Weight



### Order Codes:

ZVO-PU05-1701 to ZVO-PU60-1707  
 ZVO-RB05-2701 to ZVO-RB60-2707

### Weights:

0.5kg , 1kg-6kg (1kg increments)



### Surface Color Options:

Black (BK), Grey (GR) \* Grey only in urethane finish

### Insert Color Options:

Blue (BL), Orange (OG), Green (GN)

### Features:

|                             |                               |
|-----------------------------|-------------------------------|
| Unique ZVO Tribell shape    | Durable virgin rubber surface |
| Precision casting           | Flat surfaces prevent rolling |
| Comfortable ergonomic grips | Color elastomer inserts       |
| Premium Urethane surface    |                               |

### Warranty:

Limited 3 years (urethane)  
 Limited 1 year (rubber)





## ZVO evolution series urethane kettlebell:

The all new reshaped ZVO Kettlebell has been ergonomically improved by minimizing the pressure of impact on the users arms and wrists. Gradually sloping the face of the kettlebells the point of impact has been spread over a larger space saving your arms from aches and bruising. Featuring solid cast steel and our non-porous premium urethane surface for extreme durability.

ZVO Evolution Series urethane products have a limited 3 year warranty.

\*Patent pending.

| Order Code    | Item Description                    |
|---------------|-------------------------------------|
| ZVO-KBPU-1401 | ZVO Series 4kg Urethane Kettlebell  |
| ZVO-KBPU-1402 | ZVO Series 6kg Urethane Kettlebell  |
| ZVO-KBPU-1403 | ZVO Series 8kg Urethane Kettlebell  |
| ZVO-KBPU-1404 | ZVO Series 10kg Urethane Kettlebell |
| ZVO-KBPU-1405 | ZVO Series 12kg Urethane Kettlebell |
| ZVO-KBPU-1406 | ZVO Series 14kg Urethane Kettlebell |
| ZVO-KBPU-1407 | ZVO Series 16kg Urethane Kettlebell |
| ZVO-KBPU-1408 | ZVO Series 20kg Urethane Kettlebell |
| ZVO-KBPU-1409 | ZVO Series 24kg Urethane Kettlebell |
| ZVO-KBPU-1410 | ZVO Series 28kg Urethane Kettlebell |
| ZVO-KBPU-1411 | ZVO Series 32kg Urethane Kettlebell |
| ZVO-KBPU-1412 | ZVO Series 36kg Urethane Kettlebell |
| ZVO-KBPU-1413 | ZVO Series 40kg Urethane Kettlebell |



Our new kettlebell shape spreads area of contact against users arm, reducing the effect of impact during kettlebell rotations.

|   |   |   |
|---|---|---|
| <b>Order Codes:</b><br>ZVO-KBPU-1401 to ZVO-KBPU-1407                           |   | <b>Warranty:</b><br>Limited 3 years.  |
| <b>Weights:</b><br>4kg - 16kg (2kg increments),<br>20kg - 40kg (4kg increments) | <b>Surface Color Options:</b><br>Black (BK), Blue (BL), Orange (OG), Green (GN) | <b>Features:</b><br>Ergonomic shape for user comfort<br>Solid cast steel<br>Premium Urethane finish<br>Smaller increments in weight for a gradual progression of difficulty |





## ZVO evolution series rubber kettlebell:

The all new reshaped ZVO Kettlebell has been ergonomically improved by minimizing the pressure of impact on the users arms and wrists. Gradually sloping the face of the kettlebells the point of impact has been spread over a larger space saving your arms from aches and bruising. Featuring solid cast steel and our durable rubber surface finish.

ZVO Evolution Series rubber products have a limited 1 year warranty.

\*Patent pending.

### Order Code

ZVO-KBRB-2401  
 ZVO-KBRB-2402  
 ZVO-KBRB-2403  
 ZVO-KBRB-2404  
 ZVO-KBRB-2405  
 ZVO-KBRB-2406  
 ZVO-KBRB-2407  
 ZVO-KBRB-2408  
 ZVO-KBRB-2409  
 ZVO-KBRB-2410  
 ZVO-KBRB-2411  
 ZVO-KBRB-2412  
 ZVO-KBRB-2413

### Item Description

ZVO Series 4kg Rubber Coated Kettlebell  
 ZVO Series 6kg Rubber Coated Kettlebell  
 ZVO Series 8kg Rubber Coated Kettlebell  
 ZVO Series 10kg Rubber Coated Kettlebell  
 ZVO Series 12kg Rubber Coated Kettlebell  
 ZVO Series 14kg Rubber Coated Kettlebell  
 ZVO Series 16kg Rubber Coated Kettlebell  
 ZVO Series 20kg Rubber Coated Kettlebell  
 ZVO Series 24kg Rubber Coated Kettlebell  
 ZVO Series 28kg Rubber Coated Kettlebell  
 ZVO Series 32kg Rubber Coated Kettlebell  
 ZVO Series 36kg Rubber Coated Kettlebell  
 ZVO Series 40kg Rubber Coated Kettlebell



### Order Codes:

ZVO-KBPU-2401 to ZVO-KBPU-2407



### Surface Color Options:

Black (BK), Blue (BL), Orange (OG), Green (GN)

### Warranty:

Limited 1 year.

### Weights:

4kg - 16kg (2kg increments),  
 20kg - 40kg (4kg increments)

### Features:

Ergonomic shape for user comfort  
 Solid cast steel  
 Durable rubber surface finish

Smaller increments in weight for a gradual progression of difficulty





## ZVO evolution series studio urethane and rubber weight discs:

New original designs utilizing high end technology with ergonomically contoured lines. Our ZVO series studio discs are encased in a non-porous premium urethane surface or durable virgin rubber. Featuring precision casting and ergonomic comfortable gripping for easy loading.

ZVO Evolution Series studio urethane products have a limited 3 year warranty, studio rubber products have a limited 1 year warranty.

\*Patent pending.

### Order Code

ZVO-PU01-1601  
 ZVO-PU02-1602  
 ZVO-PU05-1603  
 ZVO-PU10-1604  
 ZVO-PUBS-1605  
 ZVO-RB01-2606  
 ZVO-RB02-2607  
 ZVO-RB05-2608  
 ZVO-RB10-2609  
 ZVO-RBBS-2610

### Item Description

ZVO Series Studio Urethane 1.25kg Disc  
 ZVO Series Studio Urethane 2.5kg Disc  
 ZVO Series Studio Urethane 5kg Disc  
 ZVO Series Studio Urethane 10kg Disc  
 ZVO Series Studio Urethane Studio Barbell Set (single set w/out rack)  
 ZVO Series Studio Rubber 1.25kg Disc  
 ZVO Series Studio Rubber 2.5kg Disc  
 ZVO Series Studio Rubber 5kg Disc  
 ZVO Series Studio Rubber 10kg Disc  
 ZVO Series Rubber Studio Barbell Set (single set w/out rack)

### Order Codes:

ZVO-PU01-1601-ZVO-PUBS-1605  
 ZVO-RB01-2601-ZVO-RBBS-2605

### Weights:

1.25kg, 2.5kg, 5.0kg, 10kg discs

### Surface Material:

Urethane (PU), Rubber (RB)

### Features:

Precision solid cast core  
 Urethane or virgin rubber surface

### Warranty:

Limited 3 years  
 (urethane)  
 Limited 1 year  
 (rubber)





## ZVO evolution series medicine ball and soft medicine ball:

ZVO medicine balls have been designed with stunning new looks and improved textured gripping action. Solid medicine balls with solid cores easily bounce and work great during tough core exercises. The new soft medicine balls are filled with sand for gentle resistance and are the perfect addition to yoga and pilates class routines. Both versions feature a durable virgin rubber surface and are available in six color options.

ZVO Evolution Series rubber products have a limited 1 year warranty.

### Order Code

ZVO-MDST-1501  
 ZVO-MDST-1502  
 ZVO-MDST-1503  
 ZVO-MDST-1504  
 ZVO-MDST-1505  
 ZVO-MDST-1506  
 ZVO-MDST-1507  
 ZVO-MDST-1508  
 ZVO-MDST-1509  
 ZVO-MDST-1510  
 ZVO-MDSF-1511  
 ZVO-MDSF-1512  
 ZVO-MDSF-1513  
 ZVO-MDSF-1514  
 ZVO-MDSF-1515  
 ZVO-MDSF-1516  
 ZVO-MDSF-1517  
 ZVO-MDSF-1518  
 ZVO-MDSF-1519  
 ZVO-MDSF-1520

### Item Description

ZVO Series 1kg Solid Medicine Ball  
 ZVO Series 2kg Solid Medicine Ball  
 ZVO Series 3kg Solid Medicine Ball  
 ZVO Series 4kg Solid Medicine Ball  
 ZVO Series 5kg Solid Medicine Ball  
 ZVO Series 6kg Solid Medicine Ball  
 ZVO Series 7kg Solid Medicine Ball  
 ZVO Series 8kg Solid Medicine Ball  
 ZVO Series 9kg Solid Medicine Ball  
 ZVO Series 10kg Solid Medicine Ball  
 ZVO Series 1kg Soft Medicine Ball  
 ZVO Series 2kg Soft Medicine Ball  
 ZVO Series 3kg Soft Medicine Ball  
 ZVO Series 4kg Soft Medicine Ball  
 ZVO Series 5kg Soft Medicine Ball  
 ZVO Series 6kg Soft Medicine Ball  
 ZVO Series 7kg Soft Medicine Ball  
 ZVO Series 8kg Soft Medicine Ball  
 ZVO Series 9kg Soft Medicine Ball  
 ZVO Series 10kg Soft Medicine Ball



### Order Codes:

ZVO-MDST-1501 to ZVO-MDST-1510  
 ZVO-MDSF-1511 to ZVO-MDSF-1520

### Weights:

1kg-10kg (1kg increments)



### Band Color Options:

Black (BK), Grey (GR)

### Outer Color Options:

Blue (BL), Orange (OG), Green (GN)

### Features:

Textured surface for improved gripping action  
 Durable virgin rubber

### Warranty:

Limited 1 year.





## ZVO evolution series core rotation medicine ball:

The new ZVO core rotation medicine balls are designed for advanced core resistance training by increasing exercise difficulty. ZVO core rotation medicine balls feature solid cores, durable virgin rubber surface, heavy duty rope for hard use, and are available in six color options.

ZVO Evolution Series rubber products have a limited 1 year warranty.

| Order Code    | Item Description                            |
|---------------|---|
| ZVO-MDCR-1521 | ZVO Series 4kg Core Rotation Medicine Ball  |
| ZVO-MDCR-1522 | ZVO Series 5kg Core Rotation Medicine Ball  |
| ZVO-MDCR-1523 | ZVO Series 6kg Core Rotation Medicine Ball  |
| ZVO-MDCR-1524 | ZVO Series 7kg Core Rotation Medicine Ball  |
| ZVO-MDCR-1525 | ZVO Series 8kg Core Rotation Medicine Ball  |
| ZVO-MDCR-1526 | ZVO Series 9kg Core Rotation Medicine Ball  |
| ZVO-MDCR-1527 | ZVO Series 10kg Core Rotation Medicine Ball |

### Order Codes:

ZVO-MDCR-1521 to ZVO-MDCR-1527

### Weights:

4kg-10kg (1kg increments)

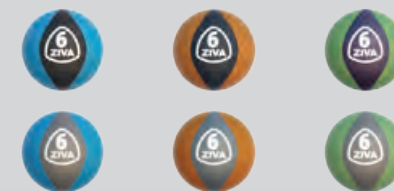

### Band Color Options:

Black (BK), Grey (GR)

### Outer Color Options:

Blue (BL), Orange (OG), Green (GN)

### Features:

Textured surface for improved gripping action  
Durable virgin rubber coating  
Heavy duty rope

### Warranty:

Limited 1 year.



# the storage: 2010

**ZIVA™** *studio*



**ST stability performance series**

*studio dumbbell storage racks*

Innovations: **studio weight storage**



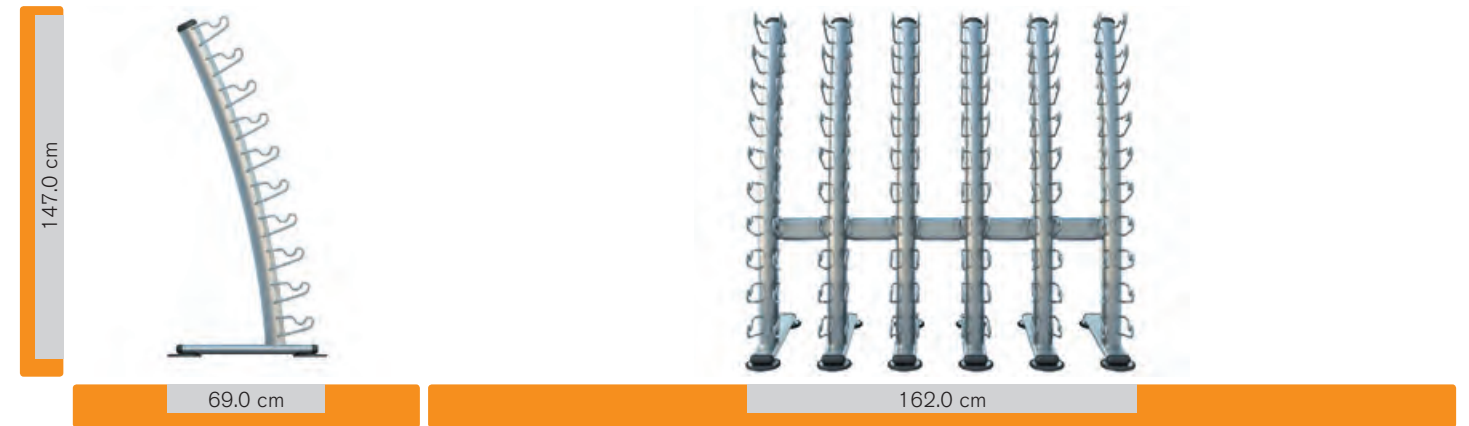
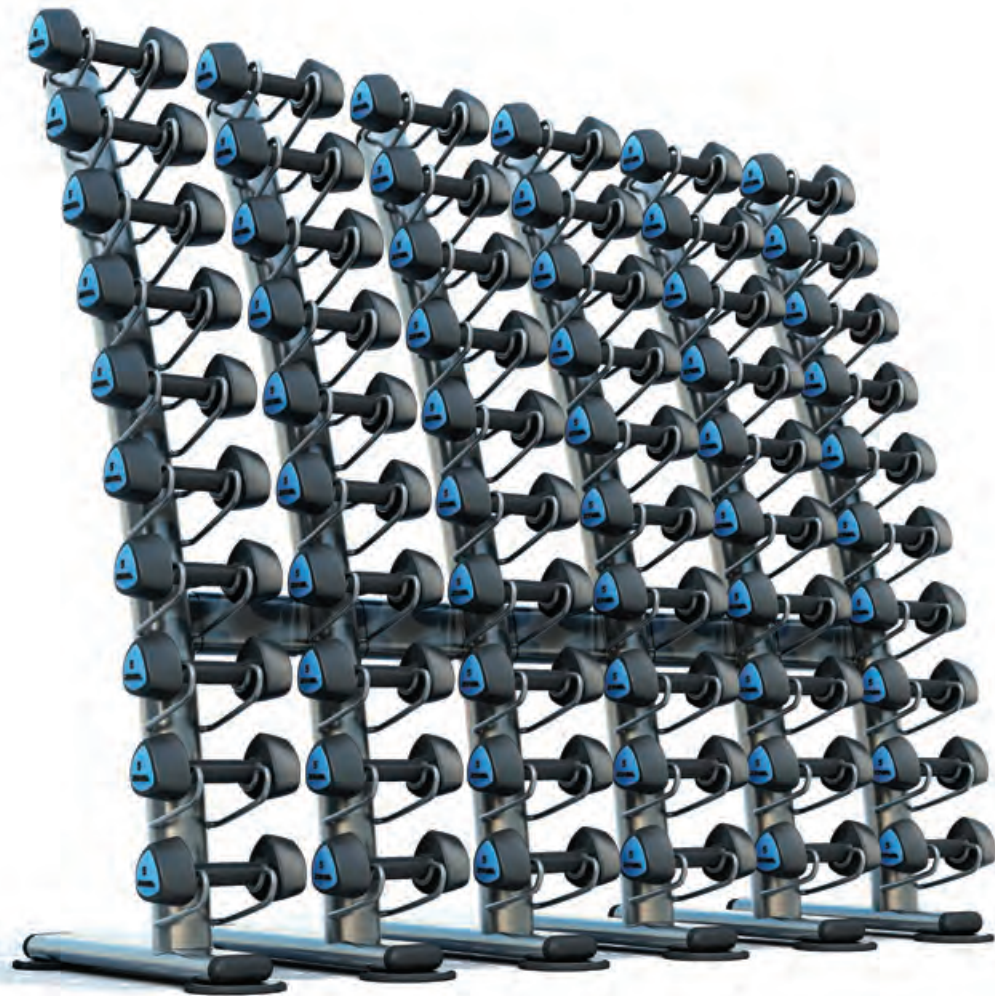

### ST performance series 30 pair vertical studio dumbbell rack:

The next generation of studio weight storage. Designed to minimize the depth of the rack, saving you space off the wall. Features heavy gauged ST (Stability) round tube steel for a strong and stable structure, and baked powdered coating. Steel wire saddles lighten overall weight and make a secure seat for your studio dumbbells. ST Performance Series is the ultimate combination of designer forms and solid construction.

ST Performance Series storage products have a limited 10 year warranty.

\*Patent pending.

| Order Code    | Item Description   |
|---------------|--|
| ZST-VS30-6001 | ST Performance Series 30 pair 6 Tier Vertical Studio DB Rack (stores 60 pcs) |

**Order Codes:**  
ZST-VS30-6001

**Dimensions:**  
Width: 162.0 cm  
Height: 147.0 cm  
Depth: 69.0 cm

**Weight**  
Weight: 75kg



**Frame Color Options:**  
Graphite (GF), Silver (SV) and White (WT).

**Features:**  
ST round tube steel  
Steel wire saddles  
Baked powdered coating  
Stores 30 pairs  
Minimal foot print

**Warranty:**  
Limited 10 years.



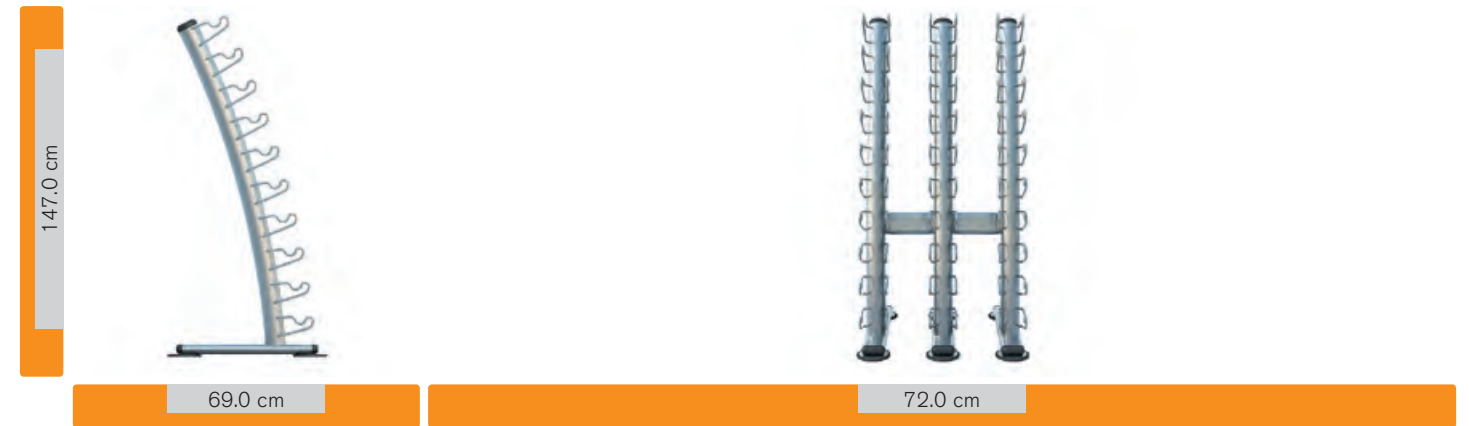
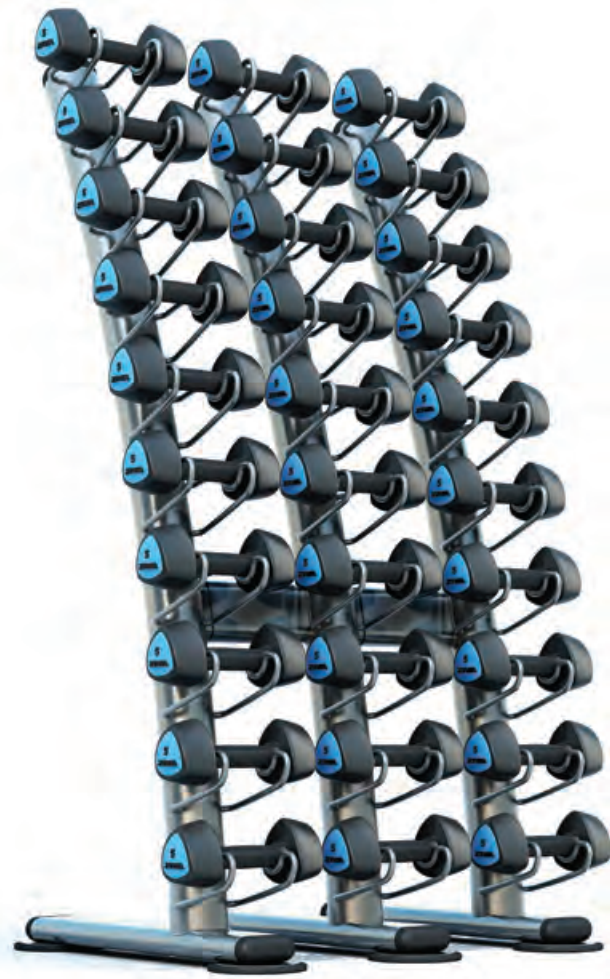

### ST performance series 15 pair vertical studio dumbbell rack:

The next generation of studio weight storage. Designed to minimize the depth of the rack, saving you space off the wall. Features heavy gauged ST (Stability) round tube steel for a strong and stable structure, and baked powdered coating. Steel wire saddles lighten overall weight and make a secure seat for your studio dumbbells. ST Performance Series is the ultimate combination of designer forms and solid construction.

ST Performance Series storage products have a limited 10 year warranty.

\*Patent pending.

| Order Code    | Item Description  |
|---------------|---|
| ZST-VS15-6002 | ST Performance Series 15 pair 6 Tier Vertical Studio DB Rack (stores 30 pcs.) |

**Order Codes:**  
ZST-VS30-6001

**Dimensions:**  
Width: 72.0 cm  
Height: 147.0 cm  
Depth: 69.0 cm

**Weight**  
Weight: 40kg



**Frame Color Options:**  
Graphite (GF), Silver (SV) and White (WT).

**Features:**  
ST round tube steel  
Steel wire saddles  
Baked powdered coating  
Stores 15 pairs  
Minimal foot print

**Warranty:**  
Limited 10 years.



# /////// horizontal storage

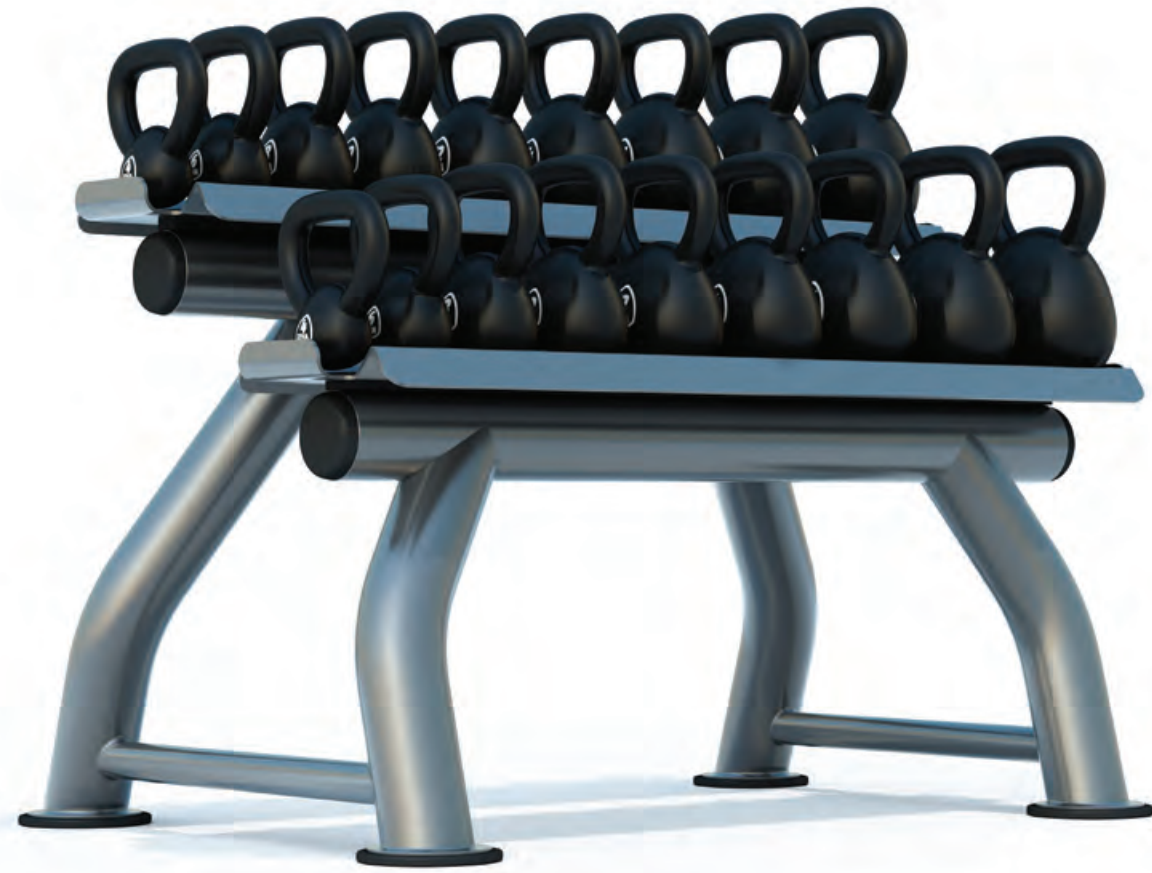

## ST performance series kettlebell rack:

The new ST performance kettlebell rack features heavy gauged ST (Stability) round tube steel for a strong and stable structure, and baked powdered coating. Heavy duty steel shelf handles kettlebells safely, and virgin rubber cover protects your kettlebells, preventing marks and scratches. ST Performance Series is the ultimate combination of designer forms and solid construction.

ST Performance Series storage products have a limited 10 year warranty.

\*Patent pending.

| Order Code    | Item Description                      |
|---------------|---------------------------------------|
| ZST-KBRK-6003 | ST Performance Series Kettlebell rack |

**Order Codes:**  
ZST-KBRK-6003

**Dimensions:**  
Width: 109.0 cm  
Height: 68.0 cm  
Depth: 76.0 cm

**Weight**  
Weight: 30kg



**Frame Color Options:**  
Graphite (GF), Silver (SV) and White (WT).

**Features:**

|                        |  |
|------------------------|--|
| Horizontal style frame | Heavy duty steel shelf                       |
| ST round tube steel    | Stores kettlebells in two optional positions |
| Baked powdered coating |  |
| Minimal foot print     |  |

**Warranty:**  
Limited 10 years.





### ST performance series 5 medicine ball tree:

The new ST performance 5 medicine ball tree with space saving designs holds five medicine balls of all styles and sizes. Minimized foot print provide you with extra room and allows you to easily fit medicine ball storage into smaller spaces. Features steel frames and baked powdered coating. ST Performance Series is the ultimate combination of designer forms and solid construction.

ST Performance Series storage products have a limited 10 year warranty.

\*Patent pending.

| Order Code    | Item Description                           |
|---------------|--|
| ZST-MDRK-6008 | ST Performance Series 5 medicine ball tree |

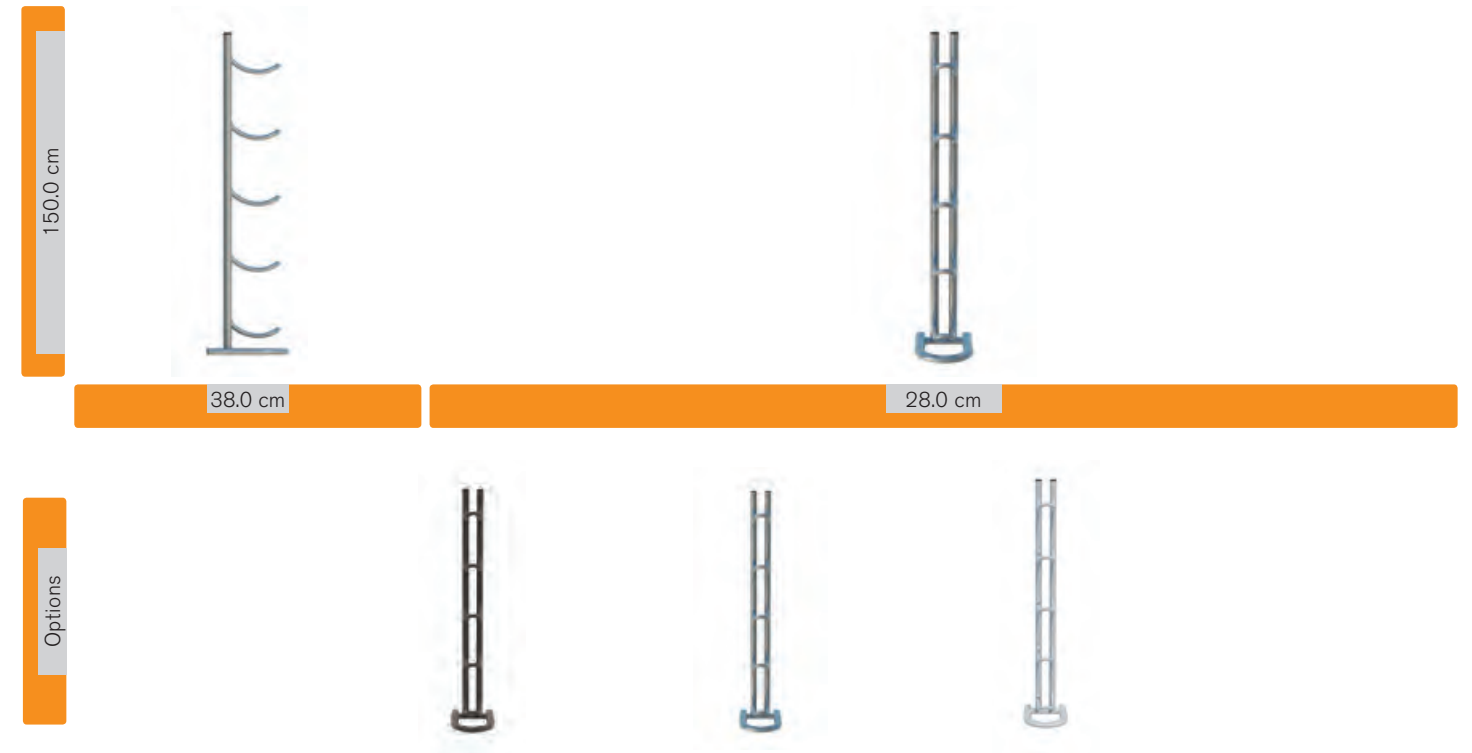

**Order Codes:**  
ZST-MDRK-6008

**Dimensions:**  
Width: 28.0 cm  
Height: 150.0 cm  
Depth: 38.0 cm

**Weight**  
Weight: 12kg



**Frame Color Options:**  
Graphite (GF), Silver (SV) and White (WT).

**Features:**  
Vertical style frame  
Baked powdered coating  
Minimal foot print  
Stores 5 medicine balls

**Warranty:**  
Limited 10 years.





### ST performance series 10 medicine ball tree:

The new ST performance 10 medicine ball tree with space saving designs holds ten medicine balls of all styles and sizes. Minimized foot print provide you with extra room and allows you to easily fit medicine ball storage into your smaller spaces. Features steel frames and baked powdered coating. ST Performance Series is the ultimate combination of designer forms and solid construction.

ST Performance Series storage products have a limited 10 year warranty.

\*Patent pending.

| Order Code    | Item Description                            |
|---------------|---|
| ZST-MDRK-6009 | ST Performance Series 10 Medicine Ball tree |

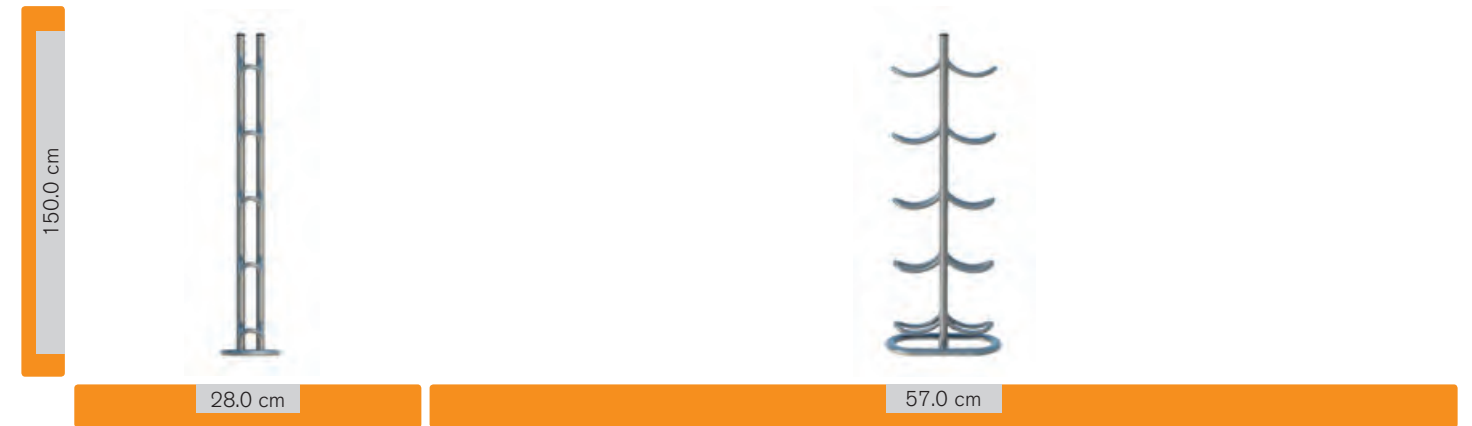

**Order Codes:**  
ZST-MDRK-6009

**Dimensions:**  
Width: 57.0 cm  
Height: 150.0 cm  
Depth: 28.0 cm

**Weight**  
Weight: 20kg



**Frame Color Options:**  
Graphite (GF), Silver (SV) and White (WT).

**Features:**  
Vertical style frame  
Baked powdered coating  
Minimal foot print  
Stores 10 medicine balls

**Warranty:**  
Limited 10 years.



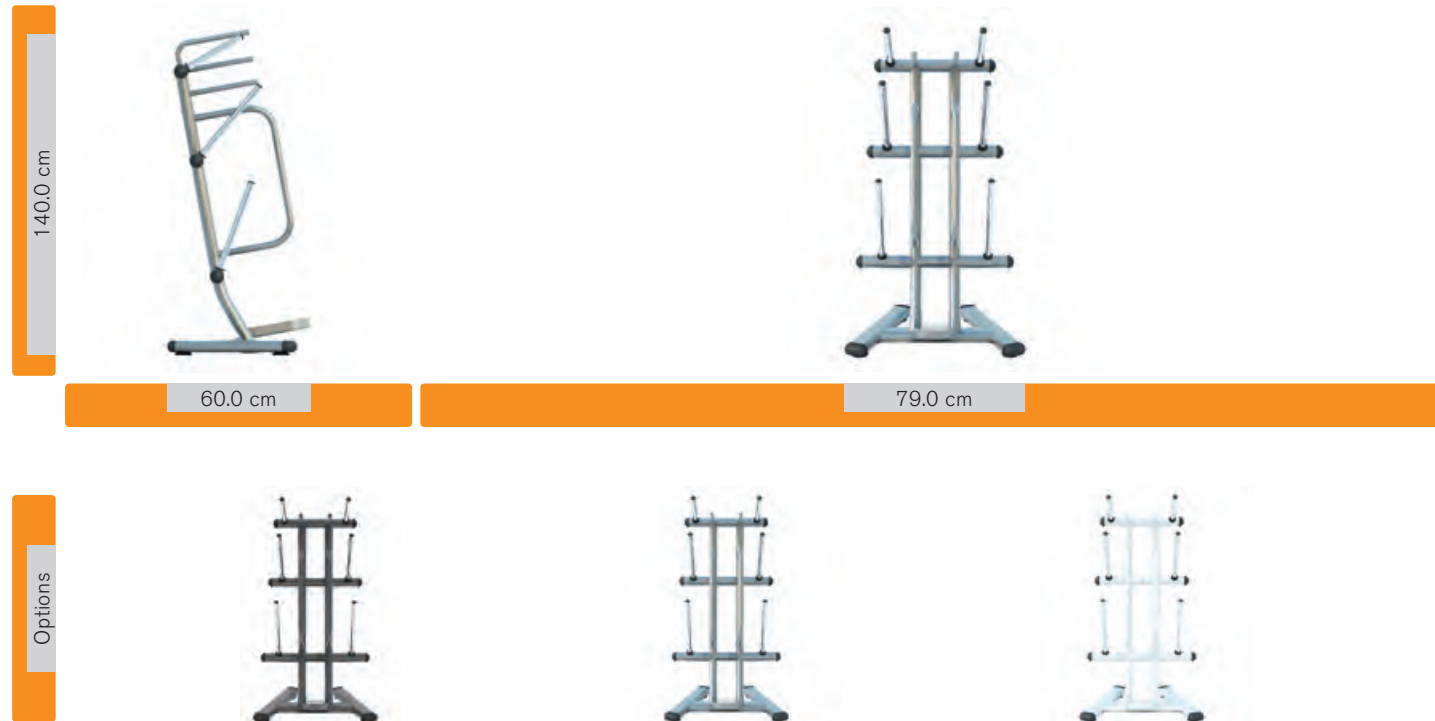

### ST performance series 10 set studio barbell and disc storage racks:

The next generation of studio weight storage. Designed to minimize the entire rack's foot print, saving you important space in your studio. Features heavy gauged ST (Stability) round tube steel for a strong and stable structure, and baked powdered coating. The angled studio disc storage make it easy for users or all sizes to remove and replace weights quickly. The 10 set studio barbell rack is designed to organize and transform your smaller spaces into a usable area. ST Performance Series is the ultimate combination of designer forms and solid construction.

ST Performance Series storage products have a limited 10 year warranty.

\*Patent pending.

| Order Code    | Item Description  |
|---------------|---|
| ZST-SB10-6005 | ST Performance Series 10 Set Studio barbell rack (stores 10 sets) |





**ST performance series 20 set studio barbell and disc storage racks:**

The next generation of studio weight storage. Designed to minimize the entire rack's foot print, saving you important space in your studio. Features heavy gauged ST (Stability) round tube steel for a strong and stable structure, and baked powdered coating. The angled studio disc storage make it easy for users or all sizes to remove and replace weights quickly. The 20 set studio barbell rack is designed for medium sized class sizes, or for extra large studios that need to pair 2 storage racks to accomodate over 30 users. ST Performance Series is the ultimate combination of designer forms and solid construction.

ST Performance Series storage products have a limited 10 year warranty.

\*Patent pending.

| Order Code    | Item Description  |
|---------------|---|
| ZST-SB20-6006 | ST Performance Series 20 Set Studio barbell rack (stores 20 sets) |







**ST performance series 30 set studio barbell and disc storage racks:**

The next generation of studio weight storage. Designed to minimize the entire rack's foot print, saving you important space in your studio. Features heavy gauged ST (Stability) round tube steel for a strong and stable structure, and baked powdered coating. The angled studio disc storage make it easy for users or all sizes to remove and replace weights quickly. The 30 set studio barbell rack is designed to organize and transform your larger spaces and accomodate large class sizes. ST Performance Series is the ultimate combination of designer forms and solid construction.

ST Performance Series storage products have a limited 10 year warranty.

\*Patent pending.

| Order Code    | Item Description  |
|---------------|---|
| ZST-SB30-6007 | ST Performance Series 30 Set Studio barbell rack (stores 30 sets) |





# vertical storage

Frame Size Options



10 set storage



20 set storage



30 set storage

**Order Codes:**

ZST-SB10-6005

**Order Codes:**

ZST-SB20-6006

**Order Codes:**

ZST-SB30-6007

**Dimensions:**

Width: 79.0 cm  
Height: 140.0 cm  
Depth: 60.0 cm

**Weight**

Weight: 30kg

**Dimensions:**

Width: 137.0 cm  
Height: 140.0 cm  
Depth: 60.0 cm

**Weight**

Weight: 45kg

**Dimensions:**

Width: 190.0 cm  
Height: 140.0 cm  
Depth: 60.0 cm

**Weight**

Weight: 63kg



**Frame Color Options:**

Graphite (GF), Silver (SV) and White (WT).

**Features:**

Easy access by multiple users  
ST round tube steel  
Stores discs, bars and collars  
Baked powdered coating

Storage for 10, 20, or 30 barbell sets.  
Minimal foot print

**Warranty:**

Limited 10 years.



ZIVA™ studio





#### TO ORDER:

Our office is open 9.00 to 6.30pm, Monday to Friday. (Local Shanghai time)

Fax: +86 21 6246 0092

Our complete range is available online from our website:

**www.zivalife.cn**

Email orders to: [dbarr@zivalife.cn](mailto:dbarr@zivalife.cn)

When placing your order by fax or email please :

- Add product codes, product description, quantity, and prices,
- Purchase order number
- State your method of payment.

#### MINIMUM ORDER VALUE

An administration charge of USD \$200.<sup>00</sup> is applicable on orders under USD \$2000.<sup>00</sup>

#### PAYMENT TERMS

The payment terms are with:

- 1\_ By irrevocable Letter of Credit
- 2\_ By TT (40% deposit payment with order / 60% upon completion of the order and after inspection but must be before shipment)

#### PRICES

All prices exclude VAT and Delivery and are in USD DOLLARS quoted FOB China Port.

#### PRODUCT

Measurements:

All sizes, weights and measurements are approximate.

#### YOUR COMMENTS

We are always delighted to hear your views, either on our range of products or any aspect of our service. Our Customer Service team can be contacted at: 86 621 6246 0030 or via email at [services@zivalife.cn](mailto:services@zivalife.cn)

#### WARRANTY

ZIVA carry a limited 12 month parts warranty against faulty workmanship for the original purchaser for all ZVO Evolution Series rubber encased weighted products, a limited 3 years for all ZVO Evolution Series urethane encased products and a limited 10 years on all ST Performance Series racks and storage frames. All warranties begin from date of purchase. ZIVA will repair or replace any item (as per the above) that can be shown to have broken due to manufacturing faults, provided the customer returns it to ZIVA for inspection. Rubber products are not intended for use on concrete floors, wood floors or especially hard rubber surfaces. Use of rubber covered free weights on these floors will void the warranty. It is highly recommended that the correct rubber free weight flooring is used.

**Note:** Rubber products should not be cleaned with detergent or acetone-based cleaners. Please clean rubber products with a damp cloth only. Dumbbells and barbells should be hand checked for tightness on a daily basis and tightened as required. Loosening of multi disc dumbbells is not covered by warranty as this style of dumbbell requires occasional maintenance. ZIVA dumbbells are designed for years of heavy use, however are not designed to be dropped, thrown or otherwise abused. Repeated misuse may result in bent handles. Dumbbells showing signs of bent handles may be excluded from warranty at the discretion of ZIVA.

#### PLEASE NOTE:

- Warranty extends to original purchaser only and is non-transferable.
- Warranty time is from the original date of purchase.
- Warranty shall not apply if the defect was caused by misuse, neglect, or normal wear and tear.
- In order to process warranty claim, item/s must be returned to ZIVA for inspection along with a returns reference number provided by ZIVA.
- Warranty does not cover transport costs. In cases where it is not economic to return multiple items we will ask for a part return supported by photographic evidence.
- Home or light commercial use products used in a commercial environment will not be covered by the warranty. If your facility is bereft of procedures/guidelines to control the misuse use of dumbbells, barbells and/or plates, ZIVA would rather not accept the order. Free weights go through probably the most extreme life of any fitness product, a correct maintenance program along with good exercise technique will prolong the life of the product significantly.

Please feel free to visit [www.zivalife.cn](http://www.zivalife.cn) for helpful maintenance information. If you have further questions please e-mail us at: [service@zivalife.cn](mailto:service@zivalife.cn)

## DELIVERY

All orders are processed and shipped in the order that they are received.

All orders are received on a FOB CHINA Basis.

Normal delivery time is EX CHINA PORT 60 Days after receipt of the PURCHASE ORDER.

Delivery times may increase around China National holidays and peak shipping seasons.

The freight delivery service you receive may vary with different carrier companies.

Carrier must be taken up direct with the carrier. Time for delivery is given as accurately as possible, but is not guaranteed, and is subjected to extension to cover delay caused by strikes, lock-outs, works, breakdowns, delay in transport, shortage of raw materials, Government regulations or requirements, or any cause beyond our control (whether or not similar to those above-mentioned).

All delivery lead times are strictly ex-China.

Law and Jurisdiction - Where the buyer is a business, this contract is to be interpreted according to Peoples Republic of China law and the parties agree that the Peoples Republic of China courts shall have exclusive jurisdiction for the settlement of any dispute arising from this agreement Without prejudice to the previous statement, ZIVA shall also have the right to file suit against the Buyer either in the China courts or wherever the Buyer is located or has a registered and/or branch office. In any event, the parties irrevocably agree that proceedings issued out of the said courts may, without prejudice to the rules of service of any court or jurisdiction, be served by delivering such proceedings in an envelope addressed to the party to be served at the address for such party set out in this contract or otherwise notified by that party to the other. All orders are accepted on the following Terms and Conditions of Trading. All orders are to be sent in writing either via email or fax and include product codes. General - In the event of any conflict of inconsistency between these Terms and Conditions of Trading, and the terms of your order, these terms prevail, unless agreed by us in writing. No alterations to your order will be recognised by us unless requested by you in writing and confirmed by us in the same way.

Acceptance - No order shall be deemed accepted by ZIVA other than upon receipt of our official acknowledgement in the form of a signed sales confirmation.

Description - All descriptions and particulars furnished in price lists, literature and other documents issued by us are as accurate as possible, but being given for general information are not to be treated as binding unless specifically confirmed in writing. Any performance figures by us are based upon our general experience and are such as we expect to achieve. ZIVA will, however, accept no liability if those are not obtained unless we specifically guarantee them in writing.

Cancellation after delivery, and/ or after delivery and installation, cannot be accepted and payment must be made in full. Any delays for the shipment of orders caused by late payments being received for any reason are strictly the responsibility of the buyer.

Storage - We reserve the right to charge storage where the customer delays shipment after the date of shipment requested by the customer has passed and proof of the orders production has been made.

Repossession by Seller - Where the buyer has committed an Act of Bankruptcy (or where the buyer is a limited company, a receiving or winding up order has been made with respect of that Company) and property in goods the subject of this contract has not passed to the buyer but remains with seller, the buyer shall, within twenty one days of such Act or Order, give notice in writing of the same to the seller and shall afford the seller reasonable opportunity and access to repossess the said goods.







#### **Asia Sales Office**

ZIVA™ Co. Ltd.  
Block 1, Suite 29 C  
123 Yan Ping Road  
Shanghai, 200042, China

T\_+86 21 6246 0030

T\_+86 21 6246 0091

F\_+86 21 6246 0092

E\_info@zivalife.cn

#### **Ziva Showroom at One Wellness**

98 Yanping Road  
Block C, 2nd Floor  
Shanghai, 200042 China

T\_+86 21 6267 1550

F\_+86 21 6267 1552

E\_info@onewellness.com.cn

W\_www.onewellness.com.cn

**[www.zivalife.cn](http://www.zivalife.cn)**